



Fakultät II – Informatik, Wirtschafts- und Rechtswissenschaften
Department für Informatik

Supporting route guidance of car drivers with a tactile display on urban roads

Dissertation zur Erlangung des Grades eines
Doktors der Naturwissenschaften

vorgelegt von

M.Phil. Amna Asif

Gutachter:

Prof. Dr. Susanne Boll

Prof. Dr. Claus Möbus

Tag der Disputation: 14. Dec 2012

Zusammenfassung

Es ist eine grundlegende Aufgabe des Fahrers einer Route zu folgen. Konventionelle Navigationssysteme bieten dem Fahrer eine schrittweise erfolgreiche Routenführung. Dabei wird die Route sowohl visuell über einen Display als auch akustisch über Richtungsansagen zugänglich gemacht. Jedoch kann durch derartige akustische und visuelle Reize der Fahrer vom Fahren abgelenkt werden und somit stellt die Nutzung eines Navigationssystems ein Sicherheitsrisiko dar. Eine taktile Benutzeroberfläche stellt eine alternative Möglichkeit dar, um Raumdaten anzuzeigen. Dennoch wurden bisher bezüglich dessen kaum Forschungen angestellt. Um eine vibrotaktile Nachricht erstellen zu können, müssen taktile Parameter untersucht werden. Während der Untersuchung der vibrotaktilen Parameter ist es wichtig herauszufinden, welche Informationen für die Zielführung notwendig sind. Weiterhin muss ein geeignetes Design für die vibrotaktilen Nachrichten gefunden werden. Danach ist es erforderlich, die Lösungskonzepte auszuwerten.

Die Methode der konventionellen schrittweise erfolgenden Routenführung ist eine erfolgreiche Navigationshilfe. Der Fahrer benötigt Informationen bezüglich der Richtung und der Distanz des Fahrzeugs zur nächsten Kreuzung. In dieser Doktorarbeit wird diese Methode zur Navigationshilfe für Fahrer an eine taktile Anzeige angepasst. Städtische Kreuzungen bestehen aus verschiedenen Typen wie zum Beispiel einfache, aufgeweitete oder kanalisierte Kreuzungen und Kreisverkehren. Die Informationen zur Richtung und Abstand zur Anzeige der einfachen, aufgeweiteten und kanalisierten Kreuzungen und unterschiedliche Techniken für die Darstellung eines Kreisverkehrs in Bezug auf dessen Struktur. Diese Doktorarbeit erforscht das Design und die Auswertung von vibrotaktilen Nachrichten zur Anzeige solcher städtischen Kreuzungen. Es wurden einige Experimente durchgeführt, um ein passendes vibrotaktil Design für ein Navigationssystem zu finden. Die Studien zeigen, dass der taktile Parameter der Position des Körpers, passend für die Anzeige der Fahrtrichtung ist. Rhythmus

und Dauer sind angemessene taktile Parameter um den Fahrer die Fahrtrichtung anzuzeigen. Die Struktur von Kreisverkehren unterscheidet sich von den anderen Typen einer Straßenkreuzung. Die Position des Körpers, der Rhythmus und die Dauer sind passende taktile Parameter, um dem Fahrer Informationen zum Kreisverkehr anzuzeigen.

In Verbraucherstudien wurden Navigationssysteme mit vibrotaktilen Design hinsichtlich Leistung, Effizienz und Arbeitsbelastung des Fahrers mit konventionellen Navigationssystemen verglichen. Die Studien zeigen, dass die Navigationssysteme mit vibrotaktilem Design in Hinsicht auf Leistung und kognitiver Arbeitslast des Fahrers besser als konventionelle Navigationssysteme sind. Außerdem konnte bewiesen werden, dass die taktilen Displays zur Anzeige der Routeninformationen genutzt werden können. Somit besteht die Möglichkeit, diese als Ersatz für momentane Benutzeroberflächen zur Navigationshilfe zu nutzen. Weiterhin könnten taktile Displays hilfreich zur Verkürzung der Reaktionszeit in einer Notsituation sein, wenn der Fahrer seine vollkommene akustische und visuelle Wahrnehmung benötigt, um die Situation zu überblicken.

Abstract

Following a route is an essential driving task. Conventional car navigation systems are designed to provide turn-by-turn route guidance to the driver. Visual and auditory displays successfully complement each other in presenting route information in conventional car navigation systems. However, a car navigation system increases the demand on the driver's visual and acoustic attention and can distract drivers from the primary task of driving, such as maneuvering the car or observing the traffic. The driver performs many primary and secondary tasks on visual and auditory displays that increase the mental workload, which is harmful for the safety of driving. A tactile user interfaces can provide an alternative way to display spatial information in the car. Nevertheless, how exactly information should be presented in a vibrotactile way is rarely explored. Tactile parameters need to be examined for designing vibrotactile messages, which help to present route information to the car drivers. In the process of exploring vibrotactile parameters, it is necessary to: (1) investigate which information is essential for route guidance of the car drivers (2) investigate appropriate design of vibrotactile messages for presenting that information (3) evaluate the developed design solutions.

The method of conventional turn-by-turn route guidance is quite successful for the navigational aid of a car driver. In this method the driver needs information regarding the direction and distance of the car from the next intersection. This thesis opt this method of turn-by-turn route guidance of the drivers with the tactile display. Urban roads consist of different types of intersections such as simple, flared, channelized and roundabout intersections. The direction and distance information use for displaying the simple, flared and channelized intersections and different technique require for presenting the roundabouts according to their structure. This thesis explores the design and evaluation of vibrotactile messages for displaying such urban road intersections to a driver. A number of experiments discover the suitable vibrotactile designs for displaying these intersections in the car navigation system. The studies show that the tactile parameter of body location is

suitable for displaying the direction information to a driver. The rhythm and duration are appropriate tactile parameters for displaying the direction information to a driver. The structure of roundabout intersection is comparatively different from the other types of road intersections. Body location, rhythm and duration are suitable tactile parameters for displaying the roundabout information to a driver.

In users studies the vibrotactile based car navigation system is compared with conventional car navigation system for performance, efficiency and workload of the drivers. The studies show the tactile based navigation was better than conventional car navigation system in terms of performance and cognitive workload of the drivers. The studies show that the tactile display can successfully be used to display navigation information to the drivers. It can be used as a substitute to current interfaces for route guidance of the drivers. Tactile displays might be helpful to decrease the reaction time in an emergency situation where the driver needs to observe the situation using visual and acoustic senses.

Acknowledgements

In the name of Allah, the Most Gracious, the Ever Merciful.

First, I am very grateful to Prof. Dr. Susanne Boll for her competent supervision during my research. She was always encouraging me in the all phases of my PhD degree. I especially thank her for support she gave me during my stay in Germany. I also thank Dr. Wilko Heuten for his guidance, time, and fruitful discussions on my research topic. I always got valuable feedback in all sittings of Susanne and Wilko. I want to thank all of my OFFIS colleagues for their cooperation and kind behavior during these years. And, I want to thank OFFIS for providing their resources. I also want to thank everyone belonging to trustsoft for professional and fun time we had together.

I always pray for my Late father that he may get a very high place in heaven, Ameen. He motivated me for higher studies and supported me on any cost. I hope he is happy that I fulfill his dream. I want to thank my mother for her support, devotion, and love. I love you so much. I want to thank Raza for being such loving and caring life partner. I pray Allah that we always live together in a strong bond. I want to thank my brothers Basit, Maaz, and Bakht for their cooperation and love. I am also grateful to my in-laws especially mother in-law and father in-law, as they are very cooperative with me in all matters of life. Rania my daughter also finished my thesis with me; you are so dear to me. I want to thank Kinga for being such a great friend during my stay in Oldenburg. I will always remember the adventures we had together. I am grateful of Ira for her assistance during my PhD. I want to thank all of my apartment mates for being polite and nicer to me. I want to thank everyone else who was kind and supportive with me during my stay in Oldenburg.

Contents

1	Introduction	1
1.1	Motivation	3
1.2	Objectives and Contribution	4
1.3	Methodology	6
2	Literature Review	9
2.1	Human Sensory Perception	10
2.2	Human Navigation in Space	14
2.3	Multiple Resource Model	18
2.4	Tactile Display: A Mode of Communication	20
2.5	State-of-the-art Tactile Displays	23
2.5.1	Tactile Displays for Blind Users and Pedestrian Users	24
2.5.2	Tactile Displays for Pilots	26
2.5.3	Tactile Displays for Bicycle Navigation	26
2.5.4	Tactile Displays in the Automobiles	27
2.5.5	Tactile displays for soldiers	28
2.6	Car Navigation Systems	29
2.7	Discussion and Summary	35
3	Navigation Information Presentation on Urban Roads	37
3.1	Urban Roads and Structure	38
3.1.1	Simple Intersection	38
3.1.2	Flared Intersection	39
3.1.3	Channelized Intersection	40
3.1.4	Roundabout Intersection	40
3.2	Scenario: Navigation in the Car	41
3.2.1	Direction	43
3.2.2	Distance	43

3.3	Requirements for Presenting Different Road Intersection Types with a Car Navigation System	44
3.3.1	Scope of this Thesis	47
3.4	Summary	50
4	Presenting Turn-by-Turn Information in Car Navigation System	51
4.1	User Situation Analysis	54
4.2	Acceptance of the Tactile Belt in Car	58
4.2.1	Survey	59
4.2.2	Results and Discussion	61
4.3	Direction Presentation with a Tactile Display	62
4.3.1	Pilot Study	64
4.3.2	Evaluation	69
4.3.3	Results	73
4.3.4	Discussion	80
4.3.5	Conclusion	82
4.4	Distance Presentation with a Tactile Display	83
4.4.1	Pilot Study	84
4.4.2	Distance encoding in vibrotactile cues	87
4.4.3	Evaluation	90
4.4.4	Results	95
4.4.5	Discussion	103
4.4.6	Summarizing the Turn-by-turn Direction and Distance Presentation with the Tactile Display	106
4.5	Summary	107
5	Tactile Design for Presenting Roundabout Information	109
5.1	User Situation Analysis on Roundabout Intersections	111
5.1.1	Scenario of Crossing a Roundabout	112
5.1.2	Crossing Roundabout Intersections	113
5.2	Exploring Roundabout Design with Vibrotactile Signals	115
5.2.1	Participants, Apparatus, Design, and Procedure	119
5.2.2	Results and Discussion	120
5.3	Design Concepts	121
5.4	Evaluation	125
5.4.1	Experiment Design	125
5.4.2	Dependent Measures	126
5.4.3	Participants	126

5.4.4	Apparatus	126
5.4.5	Procedure	127
5.5	Results	128
5.5.1	Performance	128
5.5.2	Ranking	128
5.5.3	Cognitive Workload	129
5.5.4	Usability	129
5.5.5	Qualitative Results	132
5.6	Discussion	137
5.7	Summary	139
6	Evaluation of Car Navigation Systems in High Workload	140
6.1	Performance Evaluation of System	140
6.2	Experiment 1: Tactile Display Versus Conventional Car Navigation System	142
6.2.1	Experiment Design	143
6.2.2	Participants and Apparatus	145
6.2.3	Procedure	146
6.2.4	Results	147
6.2.5	Discussion and Conclusion	153
6.3	Experiment 2: Tactile Display Versus Conventional Car Navigation System Versus Combined (Tactile and Conventional System)	156
6.3.1	A Tactile-based Navigation System	157
6.3.2	Experiment Design	157
6.3.3	Quantitative Results	162
6.3.4	Participants' Suggestion and Comments	164
6.3.5	Discussion	168
6.4	Conclusion and Summary	170
7	Contributions and Future Work	171
7.1	Summary of Contributions	171
7.1.1	The Alternative User Interface in Car Navigation Systems	171
7.1.2	Information Presentation in Visual and Audio Information Overloaded Environment	172
7.1.3	Usability Measurement in Automotive User Interface	172
7.1.4	Application of Tactile User Interface from One Domain to Another	173
7.2	Future Work	174

7.2.1	In-car Information Presentation	174
7.2.2	Multimodal (Visual, Audio, and Tactile) Car Navigation System	175
Appendices		176
A	Usability Questionnaire of Distance Experiment	177
B	System Usability Questionnaire	179
C	Workload Questionnaire (RSME)	181
D	Workload Questionnaire (NASA TLX)	182
E	Technology Acceptance Model (TAM)	184
List of Figures		186
List of Tables		190
Bibliography		191

Chapter 1

Introduction

Cars are an essential means of transportation for daily chores, leisure trips and business travel. In Germany, 81% of households owned one or more cars in 2002 [FK03]. The delivery data sets of the "MOBILITY IN GERMANY" study provide information on 61,700 persons in 25,800 households owning 34,000 cars and making 178,000 trips. According to the 2007 report, 29% of people travel by cars in Europe [Inc08]. In 2001, 72.9% of the trips made in the United States used personal vehicles [HHR06] as per an American Travel Survey. Furthermore, more than 50% of business trips and more than 70% of non-business trips were made in personal cars. The proportion of households in the United Kingdom with car access increased from 50% to 75% between 1971 and 2007 [Sur09].

A driver gets on the route between the origin and destination in order to navigate in the environment. Navigation means solving spatial problems, usually from one location to another one [Pla05]. People navigate in the environment to find a route and reach their destinations successfully. If the area is unknown, travelers consult the maps, verbal directions and navigation systems. Car navigation systems were invented to help drivers navigate on the roads and take them from their origins to respective destinations. A car navigation system is a promoted and preferred information system for cars. In recent years, a considerable increase in the demand for car navigation systems is witnessed. In 2008, the world's total shipment of car navigation devices was over 70 million units¹ which is higher than the total production of cars (around 52 million² in the world). The reason for this phenomenon is that when people travel to a new destination or make business

¹<http://www.reportlinker.com/p0138518/Global-and-China-Car-Navigation-Industry-Report-2009-2010.html>

²<http://www.worldometers.info/cars/>

or leisure trips, they need the support of a car navigation system. A car navigation system is an efficient way of providing effective and fast navigational aid to a driver. This might help a driver take orientation decisions while moving faster as compared to accomplishing the same while reading a map or remembering the verbal instructions.

A modern car navigation system offers many other services apart from its basic functionality of providing route information [Sva04] to the driver. Car navigation systems provide various functions, such as vehicle positioning, route retrieval, map database management, and visualization [TKTN09]. This information is communicated between the driver and the car navigation system with the help of a medium called a user interface. Currently, the existing user interfaces of cars are typically using visual and auditory modalities. Auditory interfaces were examined by George et al. [GGF94], who investigated the timings of presenting navigation information with the help of an auditory display. Visual displays have been available from the very first car navigation systems. The Electro Gyroator is said to be among the first car navigation system supported by a visual display. Visual displays have recently evolved into head-up [WBY⁺09] and touch screen displays. Displays are also available in other information systems for communication between a car and a driver. Therefore, visual and auditory displays are mainly present in the car. The usability issues of these visual and auditory interfaces are explored in [Bur00b]. They proposed improvements to the car navigation system interfaces. Furthermore, Burnett [Bur98, Bur00a] investigated the environmental factors that could be useful for information presentation using the visual and auditory interfaces. Throughout the last few years, a huge amount of research has been carried out on the improvement of available car navigation systems. The visual and auditory channels are available in most of the car information systems. Researchers are investigating the different methods of improving the existing channels of communication between a driver and car information systems. However, according to the MRT (Multiple Resource Theory) [Wic84], the information coming from multiple sources via common visual and auditory channels might overwhelm a car driver. This increases the risk of accidents while driving. Accordingly, there is a need of investigating new possible channels for the car navigation system to improve the communication between a car and a driver.

1.1 Motivation

Interactive tasks in cars can be divided into primary, secondary and tertiary tasks [TBK06], as illustrated in Figure 1.1. The primary task is driving the car. Secondary tasks deal with warning systems and information systems. Car navigation systems fall in the category of secondary tasks. Tertiary tasks are the driver's interaction with entertainment systems. Currently, these primary, secondary, and tertiary tasks are performed in automobiles available with visual and auditory displays. Driving itself requires attention of a driver on the road, instrument panels and other information sources, such as road signs [LFH05]. Driving a car, such as observing the traffic and road or interacting with car controls is a crucial task as compared to other tasks. Nevertheless, the importance of other available systems cannot be neglected. Thus, drivers still need to perform other secondary and tertiary tasks using the available visual and auditory channels. Figure 1.1 shows that the driver is not only driving a car but also observing bicyclists on the road and the passenger sitting with the driver might be talking to him. Visual and auditory displays of the car navigation system are used by the driver. The modern car navigation systems provide not only route guidance, but also other information, such as points of interest, vehicle positioning, route retrieval, map database management and visualization [TKTN09]. Furthermore, they deliver all this information at once regardless of the context [LFH05]. Such a huge amount of information requires a lot of concentration on the available visual and auditory channels. This causes an increase in the workload of a driver. Workload is a demand placed upon humans [Waa96]. Mental workload is directly related to the capacity of an operator spent on his or her task performance [HD01]. A driver increases his or her mental workload while performing multiple tasks on a limited number of information channels. Mental workload is critical for driving road safety. As a result, the primary, secondary, and tertiary tasks interfere with each other. Thus, increased demand due to task interference is not safe for driving in the given situation.

Excessive workload can, however, be avoided by providing an additional channel of communication in the car navigation system. Tactile interfaces or vibrotactile systems are used to communicate with users through their bodies. Tactons are structured and abstract tactile messages that can be used to communicate information non-visually [BBP05]. Hereafter, we use the term vibrotactile signals for Tactons. Brewster and Brown [BB04], van Erp [Erp02], and Heuten [Heu08] found that it was possible to transmit information to users with the help of vibrotactile signals. This is found to be a successful way of providing navigation information to the blind and pedestrians. This tactile display may benefit drivers

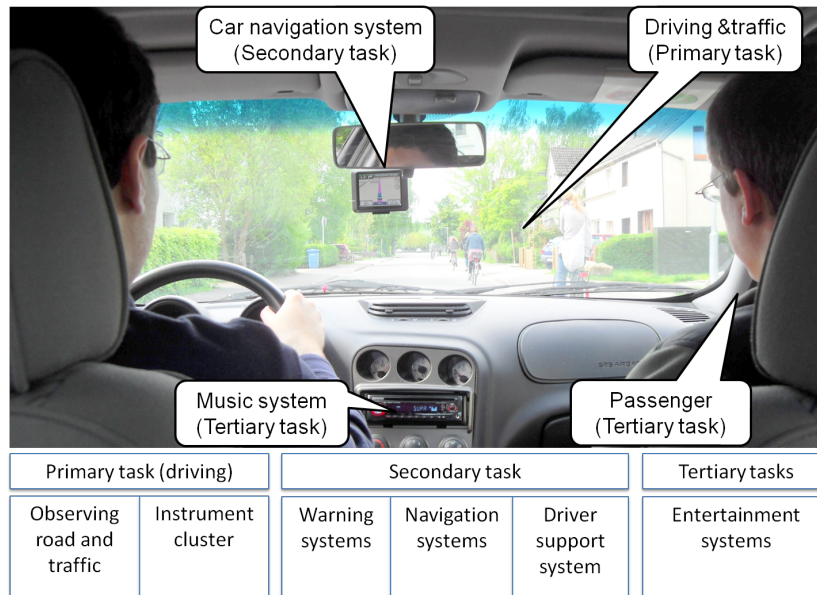

Figure 1.1: Types of task while driving the car.

as an additional channel of communication other than the visual and auditory displays. According to MRT, the information overload can be avoided on available sensory channels by adding tactile display in the car navigation system. While the tactile display is used in the car navigation systems, we named it as "vibrotactile based navigation system" This addition may lead to increase in driving safety by avoiding extra workload on a driver.

In order to incorporate the tactile display in the car navigation system, we need to define clear objectives to proceed through our research. The following section explains the objectives we want to achieve in our research and the contributions in the area of automotive user interfaces.

1.2 Objectives and Contribution

The overall objective of this thesis is to explore a vibrotactile sensory channel in a car navigation system. The vibrotactile based car navigation system might help in communication between a driver and the navigation system without imposing extra visual and auditory workload. Our aim is to accurately convey the navigational instructions that will be easier for a car driver to perceive by using the vibrotactile

system. The results will fulfill the main goal displaying the navigational instructions of a car navigation system. A driver usually aims to perform three main tasks:

1. Driving a car in a certain urban or rural environment.
2. Performing primary, secondary, and tertiary driving tasks.
3. Getting from one origin to one or more destinations.

User interfaces are available for the driver-car interaction to fulfill the above driving tasks. We aim to investigate the tactile interface for integrating with existing car navigation systems in order to achieve the following goals:

- *Fundamentals:* We identified the necessary navigational information that was presented by the conventional car navigation systems. We surveyed those instructions which were presented by the visual and auditory interfaces of existing navigation systems. We explored the different elements of the urban roads structures, such as road intersections.
- *Requirements analysis:* We investigated what type of navigational information could be presented through a sensory channel. We identify where and when this navigation information can be presented. How can the information be transmitted to drivers optimally? We intend to discover the appropriate location to integrate a tactile display in the car.
- *Designing and testing of sensory channel for route guidance:* Tactile parameters are investigated for appropriateness to encoding car navigation information. Vibrotactile signals are explored to visualize the identified navigation information. The design is tested based on drivers' performances using a new sensory channel in the car navigation systems.
- *Evaluation of the sensory channel:* The proposed designs are evaluated for their success in navigating drivers from an origin to a destination. Cognitive workload is also examined to ensure that it does not increase with the addition of a new sensory channel in comparison to existing displays. The final prototype is evaluated for design, performance in high load environment, usability, efficiency, and workload of the driver using this system.

- *Car navigation system with new sensory modality:* The designed vibrotactile components will be integrated into a single application. A tactile-based car navigation system will make it possible to navigate in the car with the support of a vibrotactile sensory display.

In this thesis, we will focus on the vibrotactile presentation of navigation information rather than on other functionalities of the car navigation systems, such as route calculation, position identification or hardware configuration. We are, therefore, not building a fully functional car navigation system - our focus is just the user interface. This research mainly contributes to human-machine interactions in the area of automotive user interfaces. We have published in workshops, conferences and magazines related to user interface designs, such as NordiCHI, AutomotiveUI, IEEE pervasive magazine, and IT-Information Technology. The design of our prototype tactile-based car navigation system is published in IEEE pervasive magazine in 2011. The survey regarding the acceptance of tactile belt in the cars is published in the adjacent proceedings of Automotive UI conference in 2009. The different parts of the experiment regarding presenting the different directions with the vibrotactile display are published in magazine of IT-Information Technology in 2012, and Automotive UI in 2010. The designs of vibrotactile signals for presenting the distance information are published in NordiCHI in 2010. We conducted an experiment to evaluate our system in high-load car environment on urban road which was published in Automotive UI 2010. This research work is interesting for car companies and communities related to human-machine interactions.

1.3 Methodology

The methodology of our research is experimentation. The direct manipulation of variables [FH03] is called experimentation, and anything that changes is called variable. According to the plan of our research, we need to develop vibrotactile designs for conveying navigational instructions in the car navigation systems. Controlled experiments are one of the most powerful methods of evaluating design or aspects of design [DFAB03]. Experiments consist of (1) treatment or design, and (2) measurement.

Treatment: Treatment consists of apparatus or material and design. Instruments or physical objects, such as all hardware and software involved in experiments are a part of apparatus or material. We explored the techniques of

visualizing navigation information using vibrotactile signals in the car navigation systems. Initial pilot studies were also an essential part of the design. In this research, we developed different vibrotactile designs to present navigation information in the car navigation systems. We identified the information required for the car navigation systems.

Measurement: Participants, procedure, and statistical measurement are the components of experimental measurement. Designs are tested and evaluated in the measurement procedure of an experiment. Our users in the experiments are drivers. We have evaluated the drivers in the real cars and on real roads. During the experiments, we collected both qualitative data in the form of observations and interviews. The quantitative data is collected by recording the user errors and questionnaires. The statistical measures on the quantitative measures are applied according to the classification of the independent and dependent variables.

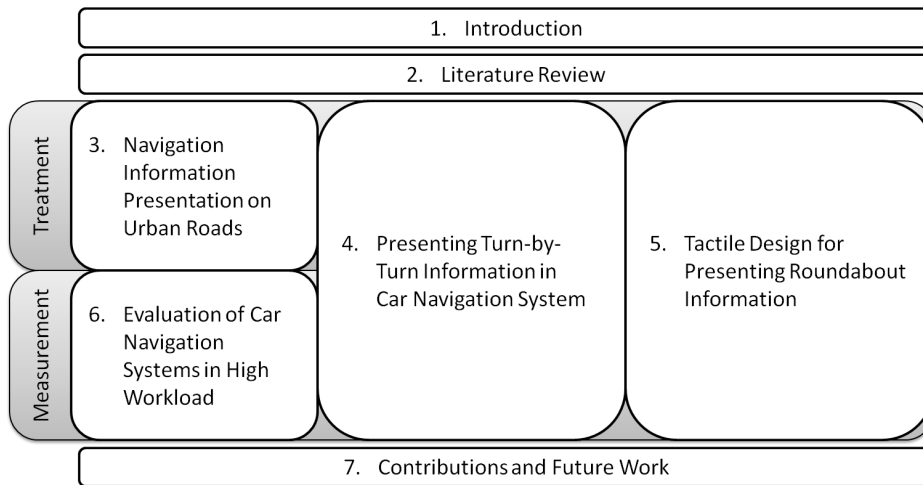

Figure 1.2: Research work in this thesis according to experimental approach.

Chapter 2 introduces the research background on tactile user interfaces and state-of-the-art systems. This chapter also provides the overview of spatial navigation and human sensory perceptions.

Chapter 3 explains the driver's scenario of navigation on urban roads. This chapter describes different types of roads and intersections. We identify the information that drivers require to navigate on the road in such environment. This

chapter formulates the research problem of our thesis and explains our research questions and approach of solving this problem.

Chapter 4 deals with a number of experiments for designing vibrotactile messages to present directions and distances. The first experiment shows the acceptability of the tactile display in the car navigation system. The second and third experiments explore the vibrotactile messages to display a direction and distance information to a driver in a car respectively. The tactile interface is designed to support a driver in the navigation activities.

Chapter 5 unfolds a vibrotactile design for presenting roundabouts information to a driver. The vibrotactile signals are expected to be different from other types of road intersections because of the structure of roundabouts. This chapter illustrates an experiment, discovering the vibrotactile design, for roundabouts presentation.

Chapter 6 reports two evaluations of the car navigation systems with different modalities. One evaluation deals with the comparison of the tactile display with the conventional car navigation systems. The second one compares the tactile display, conventional car navigation system and combined (tactile and conventional system). The experiments are carried out under workload conditions. The systems evaluate the criteria of performance, workload and usability of the navigational devices in the car.

Chapter 7 closes this thesis with representation of our contributions in the user interfaces field and future directions.

Chapter 2

Literature Review

Travelling is a part of human evolution since the creation of this world. People used to travel from place to place or region to region in different geographic locations of the world. Travelling made it possible to discover various continents. People travel for multiple purposes, such as tourism, business, visiting family and friends, seeking medical care, and shopping. For this purpose, they use diverse means of transportation, such as cars, buses, trains, airplanes and ships. In order to move from one place to another, they cross sundry geographic locations. With the passage of time, people build several types of tracks for various means of transportation, such as roads, water tracks and railway tracks. These tracks lead travelers towards their destinations. In order to reach a destination successfully, a driver or pilot needs to know exactly which track to take. For this motive, multifarious methods are used in dissimilar ages, such as magnetic compasses, maps and navigation systems. Currently, navigation systems are the most popular means of route planning in the environment. The car has great value for travelling in everyday life. Car navigation systems are mostly demanded by the drivers for route finding assistance in cars.

In this chapter, first we explain the available channels of information perception in human beings. Then, we discuss the general concept of human navigation and its background. Furthermore, we explain the MRT (Multiple Resource Theory) [Wic84] in the current driving scenario. We emphasize the tactile interface, a way of human-machine interaction, and their state-of-the-art systems and use in navigation systems. We finally explain existing car navigation systems and their functionality.

2.1 Human Sensory Perception

In order to communicate and observe things in this world, people have special sensations. People perceive events using these sensations. The meaning of perception can be feeling, observing or recording.

Perception is defined as an organism's maintenance in contact with its environment, its internal state and its posture and movement [Day71].

The study of sensation and perception shows how we acquire, process and interpret information [Mat11]. There is a difference between sensation and perception. Sensations are elementary experiences that are evoked by sensory stimulation, such as the loudness of a horn or the sweetness of sugar. These sensations combine to create a perception of organized and meaningful events (e.g. while watching a sports event on television, visual systems sense the changes in colors and light). The auditory system senses the loudness and pitch of the sound coming from the speakers. From this mass of sensations, viewers can understand the perception of events.

Researchers have proposed various models of perception in order to clarify the process. The general model of the perceptual system is defined in [HR71], as shown in Figure 2.1. This system receives some kind of input (stimulus) from its environment. It will then process that input and produce its output (response). The input can be any event happening in the environment. The output is a person's understanding of that event and his or her action on it. In the act of perception, an internal code is used for the internal processing of sensory inputs. Neurons are the carriers of this internal code which respond in an all-and-none manner by broadcasting the pulses of electrical energy.

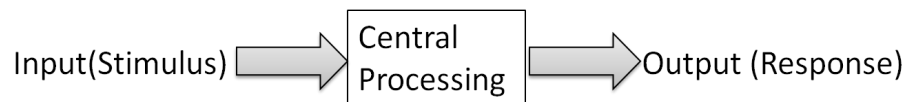

Figure 2.1: Generalizing the model of perception [HR71].

The brain of human being is able to attend selectively between various inputs from an event. Consequently, it processes a lot of information from multiple channels in parallel Figure 2.2. This explains the ability of a person to perceive information simultaneously from different incoming resources of visual, audio,

and haptic channels, as a result the brain interprets them accordingly. The human brain has, therefore, an ability to understand the parallel information coming from various channels.

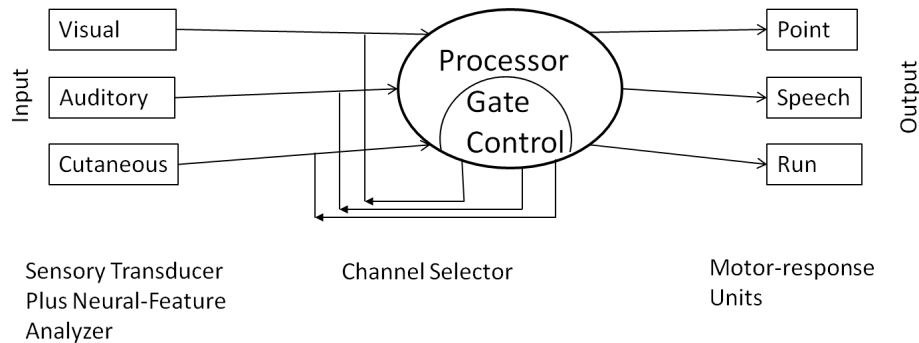

Figure 2.2: Model of parallel processing of human senses by [HR71].

In general, humans use different senses to receive information from their environments. Human senses are grouped into five types, as proposed by Aristotle [Fie66], often called modalities: (1) sense of vision, (2) sense of hearing, (3) sense of touch, (4) sense of taste, and (5) sense of smell. Sight and hearing have a greater degree of differentiation in human beings - these are called higher senses. In designing user interfaces, the sense of vision and sense of hearing are considered to be important. Currently, researchers are investigating the sense of touch as an alternative channel of communication between humans and machines. In fundamental interface research, the senses of vision and hearing are used more frequently. In the following, we explain the three important senses, i.e. vision, hearing, and touch in detail.

- **Sense of vision:** The human eye is a medium that is used for the sense of vision. Three types of layers exist in an eye: (a) outer, (b) middle, and (c) inner. The outer layer of the eye is protective. The middle one is nutritive and inner one sensory. The light-sensitive tissue retina is an essential part of the inner layer which is classified as a receptor tissue for the vision. The middle layer consists of choroid which supports the metabolic process of the eye and also consists of blood vessels. The outer cover is formed by sclera, tissues made up of tightly connected fibers. The outer and middle layers of the eye transform into transmitting refracting agents for the reception of light. The front part is called the cornea and behind it is situated the iris. Regulation of the light is done in the iris. The pupil opens and closes on the

reception of light. A crystalline lens lies behind the pupil. This lens divides the eyeball into two cavities. The retina has two areas of interest, namely the fovea centralis and optic disc. On the optic disc, the retina comes together and leaves the eye, thus forming the optic nerve [Fie66]. The optic nerve leaves the eyeball and proceeds to the brain. The fibers originating from the inner half of the retina cross over in each optic nerve [Lan56].

- ***Sense of hearing:*** Like vision, the sense organs of hearing are divided into three parts: the outer ear, the middle ear and the inner ear. The most visible part of the auditory organ is the earlobe or pinna. This acts like a funnel and allows sounds into the inner parts of the ear. This part leads to the eardrum, which vibrates sound and separates the middle ear from the outer ear. On the inner side of the eardrum, there is the middle ear cavity. There are two openings near the middle of this cavity, the oval window and the round window. Vibrations from the eardrum are transferred through the ear cavity. The oscillations are intensified by a lever system of three tiny bones, namely the (1) hammer, (2) anvil, and (3) stirrup. The hammer vibrates within the eardrum, and this is attached to its center. These vibrations are transferred to the anvil which is attached to it with elastic muscle, and this activates the stirrup through the lever system. As a result of these movements, the stirrups are driven back and forth in the oval window. The Eustachian tube is situated between the middle ear cavity and throat, and this balances the pressure [Fie66]. In the inner ear, the vibrations enter the liquid-filled cochlea through the oval window. The cochlea is divided in half called the cochlear partition and helicotrema. The cochlear partition contains a large structure called the organ Corti. The important parts of this structure are the basilar membrane, tectorial membrane and hair cells. These hair cells are the target of vibration; when they bend, it causes the release of a chemical transmitter onto the nerve fiber. The nerve fiber generates electrical signals that transfer towards the brain [Gol80].
- ***Sense of touch:*** "Feeling referred to sensation aroused through stimulation of receptors in the skin; touch, warmth, cold and various blends of these attributes" [CF78]. Cutaneous senses represent the quality of the skin as multiple receptors: touch, warmth, cold, pain, tickle, and itch [Gol80]. Human skin is the largest organ of the body. It is estimated that an adult body is covered with 8 pounds and 22 square feet of the skin [DGSH09].

There are three layers of the skin. The outermost is called *epidermis* which

is made of the tough protein keratin consisted in keratinocytes cells. There are several layers of keratinocytes that constantly grow outwards as the exterior cells die and flake off. This covering of the dead skin is known as the stratum corneum or horny layer. It is available in varied thickness. The defensive Langerhans cells reside on epidermis which alerts the body's immune system to viruses and other infectious agents.

The next layer is called *dermis* which is bonded with the epidermis. This layer gives the organ its strength and elasticity using the fibers of collagen and elastin. The body temperature is regulated by the blood vessels by increasing blood flow to the skin to allow heat to escape or by restricting the flow when it is cold. This part of the skin consists of a network of nerve fibers and receptors that helps pick up the feelings, such as touch, temperature, and pain and transmits them to the brain. Some important skin receptors are the Ruffini endings, Krause end bulbs, Pacinian corpuscles, Merkel discs and Meissner corpuscles. All the end organs are surrounded by the ends of the nerve fibers. These nerve fibers travel from the skin to the spinal cord towards the brain. The dermis also consists of the hair follicles and glands with ducts. These glands are responsible for various functionalities, such as bringing body waste, causing body odor and oils of lubricating the hair and skin.

The base layer of the skin is called the *subcutis* which holds a seam of fat laid down as a fuel reserve in case of food shortage. It also protects in accidents by working as insulation and cushion.

The previous work of Weinstein explored diverse areas of the body to punctuate detection thresholds and provided the experimental verification of tactile stimulation at different body parts [Gol10]. The studies found that certain areas, particularly the finger skin and facial areas are most sensitive to the vibration among all body parts. On finger tips vibratory stimuli in 250 Hz range is as low as 2 mm. Vibratory threshold is critically dependent on vibration frequency. Verrillo and colleagues established threshold just below the palm area of the hand for frequencies between 25 to 600 Hz. The frequencies reach its minimum point at 250 Hz and increase with as further increased. Below 40 Hz, there is no particular change; the change is varied.

The threshold of larger frequencies varies according to the contractor size, such as larger contractors produce lowest thresholds. Thus, the tactile sensitivity shows a spatial summation, the ability to sum energy from different

locations to minimize the total energy required for detection. Vibratory detection has also been shown to exhibit temporal summation, the ability to sum energy over extended stimulus durations, in a manner similar to visual and auditory modalities.

The vision and touch are mostly used senses in current technology for transmission of messages between human and systems. However, with the passage of time, other human senses are being investigated as communication channel for linking humans with machines, provided the characteristics of skin, the sense of touch is the most eligible channel that humans can use to communicate with the technology. In order to explore the sense of touch in the automotive technology, we first need to understand the fundamental concepts of human mobility and space.

2.2 Human Navigation in Space

A person travels through space. Space is a poorly defined concept. Some researchers have classified space as a dichotomous concept, where space is referred to as small scale and large scale. Small scale can be seen from a single viewpoint, whereas large scale needs movement to see it [KB02]. Freunds Schuh and Egenhofer [FE97] distinguished between six types of space:

- *Manipulable object space*: This space is smaller than the human body and can be seen from a viewpoint.
- *Non-manipulable object space*: This space is larger than the human body but smaller than a "house" and requires locomotion to experience it.
- *Environmental space*: This space consists of non-manipulable, large spaces that require movement to experience them such as inside a house, neighborhood and city-size spaces.
- *Geographic space*: This space is very large and non-manipulable, and thus it cannot be experienced with locomotion owing to particle reasons. These include larger than city size space, states, counties, and the universe.
- *Panoramic space*: These are small to large non-manipulable spaces, for instance, rooms, fields, and auditoriums. We can experience panoramic space in the view of a room.

- *Map space*: This is non-manipulable, small-and large-sized space. This space does not require movement to experience it because it is a symbolic representation of some areas, states and the world.

According to the definition of geographic space, other spaces can be subset of it. A person requires different cues for moving correctly within space. It is more common for a person to use map space to experience unknown environmental space. This helps our abstract understanding of unknown environments. On the basis of this understanding, a person orients or navigates through space for movement in environmental space. According to [Pla05]:

"Navigation means solving a spatial problem, usually to get from one location to one or more other locations. Contrary to pure orientation, navigating people move and they have got one or more specific goals. So, we can orientate without navigating but we cannot navigate without orientating."

Navigation is literally the "art of ship mastery" but in the context of driving from one place to another, it means the solving of a spatial problem to move from an origin to a destination.

"Orientation [HT73] is defined as two lines on a flat surface, the sign angle of the rotation of a point moving about a fixed point in the plan and the sign angle of a movement along a line. Movement can be clockwise or anticlockwise (see Figure 2.3)."

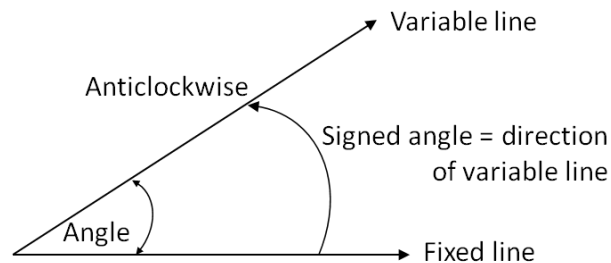

Figure 2.3: The basic geometric concept of orientation with the help of lines, points, and angles [HT73].

According to [Pla05]:

"Orientation means knowing about one's actual position and the spatial relations between various locations. As the other locations can be located outside of our actual perceptual range, orientation is a predominantly cognitive process."

The process of orienting or navigating on foot or in a vehicle is called human way-finding [MF90]. The goal of human way-finding is to relocate from one place to another over large areas. The concept of relocation from one place to another is called travelling. While travelling, people can move from place to place, and back to their origins. Locomotion means displacement from one location to another. Travelling is a way to know various places. While travelling, a person moves to experience different types of spaces. Travelling is performed in various types of geographic and environmental spaces. A person can travel through a building by passing through different rooms and doors. In addition, travelling is performed through diverse countries and cities by crossing different streets, and roads [Heu08].

Travelers can make orientation decisions of a route they follow. Often, travelers are successful at reaching their target localities. They might take wrong routes but they try to reach their destinations by taking alternative ways or revising the paths. In the whole process of travelling, travelers have a specific cognitive ability to carry out this travelling task. This ability is called a cognitive map of environmental space. Travelers have a cognitive map about the environment in which they are travelling.

A cognitive map is a term that refers to an individual's knowledge of spatial and environmental relations, and the cognitive processes associated with encoding and retrieving information of which it is composed [KB02].

A traveler tends to make orientation decisions on the basis of cognitive maps. According to Cadwallader (1976) and Gärling (1985) [KB02], cognitive maps affect four types of spatial decisions:

1. The decision to stay or go.
2. The decision of where to go.
3. The decision of which route to take.
4. And, how to get there.

According to these four steps, the decision as to whether to go or stay at home should be made by a traveler. This decision may be influenced by many factors, such as the urgency to travel, physical conditions and the circumstances of the traveler. Knowing the destination is important for the success of the journey, when travelers make decisions to go somewhere, they estimate the length of the route from the origin to destination. In this process, they choose among the available means of transportation or walking. According to Allen [All07], distance is an important factor that influences the choice of driving rather than walking. Information on distance is retrieved from one's cognitive map of familiar environments, unfamiliar environments as well as maps, and road signs. There are many reasons why people choose a car for their short trips, as proposed by Mackett [Mac03]:

- To carry heavy goods from one place to another.
- To provide a lift to another party (e.g. taking a friend to another friend's house).
- Time pressures (e.g. required to meet someone at a train station).
- Need to use a car for another trip prior to returning home (trip chaining).

The usage of automobiles is, therefore, common among people for going from one place to another. The drivers familiar with the location, find destinations by using their cognitive maps in that environment. The drivers unfamiliar with the environment, however, need the help of road signs, maps, car navigation systems, and oral route guidance to navigate in the environment. People, therefore, prefer to get help of assistance systems, such as car navigation systems in unfamiliar environments.

Modern cars having facility of car navigation systems for route guidance of the drivers. Like other objects, the human senses or modalities are fundamental to make possible communication between humans and machines. So, these car navigation systems enable drivers to interact via visual and auditory displays.

Visual displays Visual displays are very common interfaces. These interfaces exist on the small screens of very simple mobiles to large displays. An ambient display is a way of displaying information in alternative, non-screen ways [MO09]. These interfaces use the whole environment of the user for the interaction between user and system [Gro03]. For example, brightening space with different colored light can symbolize a specific event.

Auditory displays The way of displaying non-visual information in the form of speech or sound is through auditory displays. There are two ways of presenting auditory information: (1) speech, and (2) non-speech. Speech can be specific to certain information. It is dependent on the culture, and type of language spoken to understand the meaning of the provided information. The interface presents the information in the form of general speech in a certain language. Non-speech sounds can consist of auditory icons to present specific information [Gav87]. Auditory icons are caricatures of naturally occurring sounds that can be used to provide information about sources of data.

The current car navigation systems offer visual and auditory interfaces for route guidance. A driver uses his or her sense of vision to observe the navigation data generated by car navigation systems. The acoustic sense of a driver is used to listen to the instructions of the car navigation system. The driver is able to interact and play with technology using his or her visual, and hearing senses. Visual and auditory displays are successful at providing spatial information. Car navigation systems, however, demand more of a driver's visual and acoustic attention while driving and they are, thus likely to distract the driver. The visual attention of the driver is essential for the primary tasks of driving, such as steering the car, using brakes and controls as well as observing the traffic. Pauzie and Marin [PML91] found that aging drivers spent 6.3% and young drivers spent 3.5% of their driving time glancing at the screen. Auditory displays, by contrast, are challenging in a noisy environment. The driver performs a multiple number of primary and secondary tasks on visual and auditory displays that can impose mental workload [GHK08] and distraction [RLY09], which is not safe while driving.

2.3 Multiple Resource Model

The multiple resource model [Wic08] improves the efficiency of time sharing. Especially, when multiple tasks are imposed, the model is still challenged by the issue of adding another level to the modalities dimension related to the tactile interface. The multiple resource model of task interference [HW03] can be explained with the help of a driving scenario. A driver uses a car navigation system with a visual and auditory display while driving a car. This will involve resources at different levels: perceptual (e.g., localizing the position of the car on the map), cognitive (e.g., determining the relative position of the vehicle on the road in a

given environment), and response (e.g., deciding about taking lane or turning the steering wheel). In Figure 2.4, the demand on the driver owing to task interference is explained in different stages:

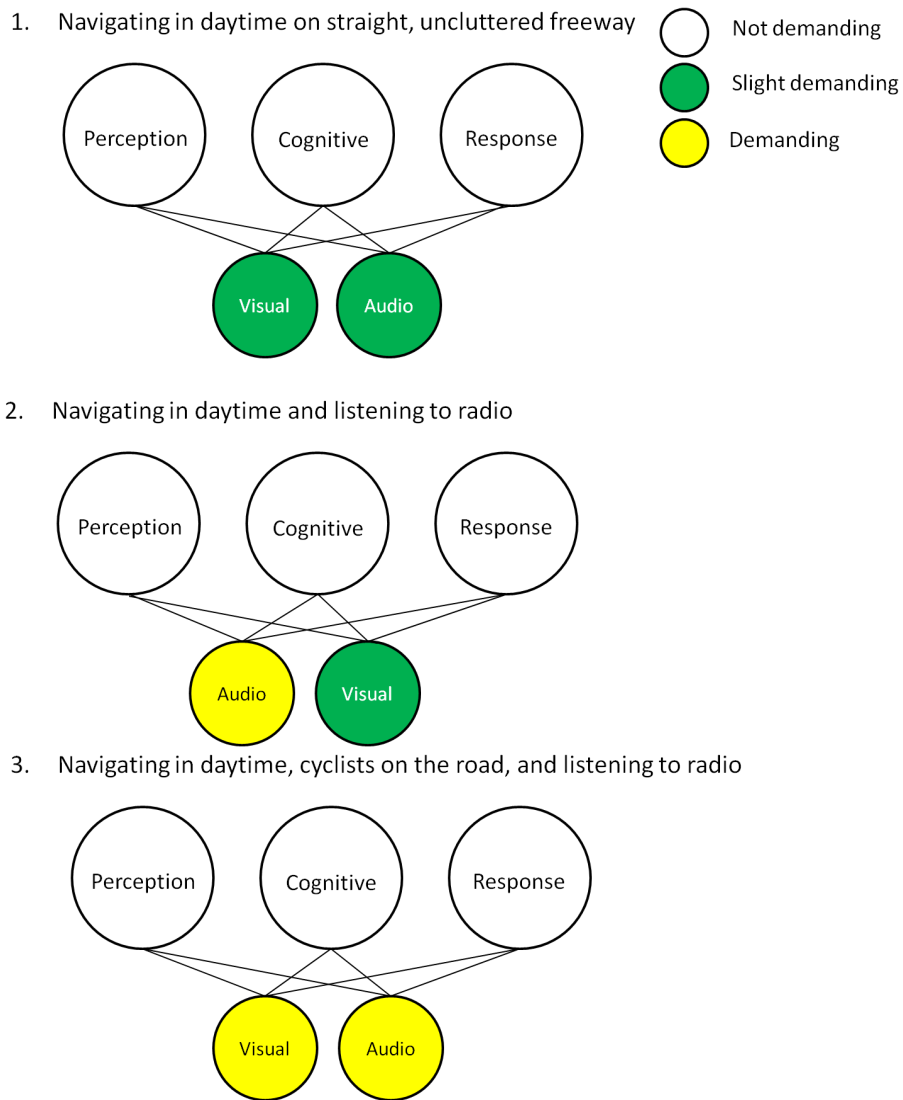

Figure 2.4: Visualization of model of task interference discussed in [HW03].

- Each task is encoded in terms of its dependence on given resources. In the first stage, the driver is driving in the daytime on a straight and uncluttered

road with no traffic. The driver is navigating by using the visual and auditory displays of a car navigation system. In this situation, the driver has the slight demand on visual and auditory senses. However, if the driver starts listening to the radio, the demand on the auditory sense will increase. Suddenly, some cyclists move in front of the car. Now, demand will increase on the visual sense of the driver.

- Demand scalar is used to judge the degree of task difficulty; this is the additive combination of values in the demand vector. In the previous example, if the demand is 2, then the vector will be (2, 2, 2). The demand scalar will, therefore, be 6. That is much more than the initial value of 3.

The MRT of task interference shows how tasks impede each other with limited resources. The interference on tasks results in increased demand. A driver can get packed with these tasks and become distracted from crucial tasks. This demand can be reduced by increasing the number of channels for task distribution. In car navigation systems, additional input and output channels of communication can be introduced for route guidance. Therefore, drivers will always have a chance to keep receiving navigation information while performing other in-car activities. A tactile channel can be added to the existing visual and auditory channel so that the workloads of users might be reduced and performance increased.

While driving a car, a driver is required to concentrate on the road using visual and acoustic abilities. Other in-car systems also allow communication using vision and hearing. Since the human brain is able to process information in parallel with different channels, researchers are investigating other channels of communication for human-technology interaction technology. The sense of touch is one important channel being investigated. The tactile sensation is one of the important types of touch.

2.4 Tactile Display: A Mode of Communication

"Engineering systems possessing mass and elasticity are capable of relative motion. If such a system repeats itself after a given interval of time, the motion is known as vibration" [Set64]. "Vibration is mechanical movement that oscillates about a fixed (often reference) point" [Man05]. Vibration is a kind of mechanical wave that transfers energy and no matter. A mechanical structure is needed for vibrations to travel. This mechanical structure is required to be a part of a machine, vehicle, tool or person, otherwise, the loss of coupling will not propagate

the vibration. People receive a sensation of vibration stimuli when this mechanical structure is the skin of human beings.

Touch includes those sensations aroused by either the single or the repeated (vibration) mechanical deformation of the skin, and this is referred to as tactile sensitivity [CF78].

This is sometimes used to transmit information to a person, called tactile interface or tactile display. The sense of touch is crucial to our perception of the world. Humans often tap, rub or envelop objects during exploration [WMVO05].

People are usually exposed to two types of vibrations: localized vibration and whole body vibration [Man05].

- Localized vibration only affects a specific part of the body, such as the hand/arm system. This type of vibration is caused by holding a tool, piece of work or control device.
- Whole body vibration affects the whole body. This type of vibration is transmitted through the seat surface, backrest or floor. A person can experience this type of vibration while travelling in a train or car.

Localized vibration can be presented in the environment of whole body vibration. For this purpose, the localized vibration threshold needs to be more than the whole body vibration. The localized vibration is used to present specific information in many devices, such as warning signals. The commercial automobiles provide vibrotactile warnings prompts to drivers using the localized vibration. Full vibrotactile signals are regarded as "Tactons".

"Tactons, or tactile icons, are structured abstract messages that can be used to communicate messages non-visually" [BB04, HB07]. Tactons can be constructed using parameters, such as frequency, amplitude and waveform, duration of a tactile pulse, rhythm, and body location (see Figure 2.5). Tactile parameters play an important role in encoding the messages in vibrotactile signals.

- *Frequency*: Period is the time required for periodic motion to repeat itself; the frequency is the number of cycles per unit of time [Set64]. Different ranges of frequencies can be used in Tactons. A frequency range of 20-1000 Hz is perceivable [BB04]. Nine different levels of frequencies are perceivable, and the difference between each level is 20% [Erp02]. At low frequencies (below 100 Hz), users sense periodicity or buzzing, while at high frequencies, they feel a more diffuse, smooth sensation [GDM02]. Change in amplitude also affects the perception of frequency.

- *Amplitude*: The magnitude of change in an oscillating variable with each oscillation is called amplitude. No more than four different levels should be between the detection threshold and the comfort or pain threshold [Erp02]. Vibration amplitude is plotted as a function of frequency, and two families of curves are combined to form a single set of lines [VFS69].
- *Intensity*: Intensity is a measure of energy flux, namely the rate at which the energy crosses the unit area. It is, therefore, the product of energy density (kinetic plus potential) and wave velocity [Pai05]. Intensity can be a function of frequency and amplitude. Vibrotactile signals might contain ranging from the threshold of detection up to the limit of discomfort [GDM02]. Frequency and amplitude are linear functions, and they decrease linearly with decreasing voltage.
- *Waveform*: Waveform is the shape of a pulse wave. The perception of waveform is limited and hardware-dependent. Owing to poor frequency analysis, different vibrotactile stimuli cannot be perceived by auditory systems [GDM02]. Users can differentiate between sine waves and square waves, perceiving them smooth or rough respectively, but with difficulty [Gun01]. Thus, the parameter of waveform cannot be considered in designing Tactons.
- *Duration of a tactile pulse*: The time length of vibrotactile stimuli is called its duration. Vibrotactile stimuli that have a longer duration can be perceived as gradual attacks and decays, whereas stimuli with a shorter duration might be more smooth, and flowing tactile phases [GDM02]. The minimum time for a perceivable signal should be 10 ms [Erp02]. The parameter of duration is important for designing vibrotactile signals.
- *Rhythm*: A composition of different pulses is called its rhythm. A group of different pulses of different durations can be composed into a rhythmic unit [BB04]. Rhythm is a very powerful parameter for both the sound and touch. The vibration can be composed of different durations, and thus, it can form different events that occur many times on the same area of the skin.
- *Body location*: Where vibrotactile encoding occurs, is important. Different locations on the body have different levels of sensitivity. Some body parts have a high spatial resolution, e.g. fingers, hands and face, compared with other parts [Erp02]. Spatially distributed vibrators can encode information

in the position of simulation across the body [BB04]. Body location can, therefore, be used as a parameter for encoding vibrotactile information.

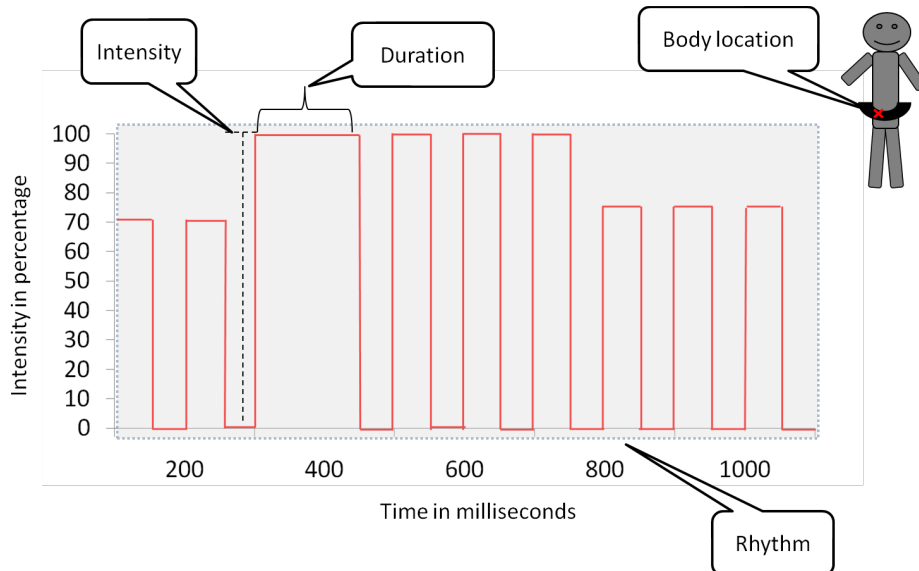

Figure 2.5: Illustration of tactile parameters.

Tactile parameters have been investigated previously for encoding vibrotactile information. Some parameters have been found to be flexible for encoding information, and others have not. The literature on vibration can be found in many disciplines, such as physics and computer science. The appropriate vibrotactile parameters that can be used to encode information have already been identified in previous research. We can evidence a huge amount of research on the tactile user interface. This interface might be a suitable interface in the situations when visual and auditory interfaces are having limitations. In the next section, we present the previous research on the tactile interfaces.

2.5 State-of-the-art Tactile Displays

The tactile user interface is a potential display to communicate between users and machines similar to visual and auditory user interfaces. In the previous research, the tactile interface is investigated as an alternative human computer display in diverse systems. The tactile interface is a usable channel of communication for

different types of users, such as blind, pedestrians, and pilots etc. In the following, we explain state-of-the-art tactile displays, and their utilization in dissimilar areas.

2.5.1 Tactile Displays for Blind Users and Pedestrian Users

Previous research has shown that tactile displays can be effectively used to provide navigation aids to the pedestrians and blind users. ActiveBelt[TY04] consists of a number of vibration components integrated into a belt or a vest. These vibration components are equally distributed around the person's body and activated to show him or her a direction. McDaniel et al. [MKC74] presented a scheme for using tactile rhythms to convey intimate, personal (close and far) and social interpersonal distances to blind users. They conducted an experiment to evaluate participants' performances in identifying proposed tactile rhythms. The results showed that participants were able to identify proposed rhythms and found them intuitive for the given application. Ross and Blasch [RB00] developed a shoulder-tapping system that provides route information with tactile feedback to visually impaired persons. These studies indicated the effort of researchers investigating non-visual and non-acoustic interfaces for visually impaired users. In addition, the tactile interface was broadly investigated for route guidance for pedestrians.

The tactile Wayfinder[HHPB08] was evaluated for the task of pedestrian route guidance. This supported pedestrians' orientation, choice of route, keeping track and recognition of the destination. Tan and Pentland [TP97] used a tactile belt to display cardinal directions to the user, e.g. north. Displaying the directions of locations, e.g. way-points, has been investigated as well. van Veen et al. [VSE04a] showed that people could easily follow routes if the direction of the current way-point was being displayed by a tactile belt. van Erp et al. [EVJD05] investigated different distance encoding schemes with pedestrian participants. A vibration rhythm was used to code the distance and the body location was used to code the direction. Straub et al. [SRF09] used a vibrotactile waist belt to encode distances for pedestrians. They used four distance encodings based on the parameters of intensity, frequency, position, and patterns. Pielot et al. [PKB10] presented the position and spatial distance of several people with the help of a tactile torso-based display in a fast-paced 3D game where the positions of team members were crucial for the success of the game. The results showed that the locations of team members could be effectively processed with the help of the tactile display. The team showed better team play and higher situation awareness. CabBoots [Fre07] is prototype system that consists of a pair of shoes equipped with sensors and mechanics connected to a computer running control software.

The prototype was developed for the route guidance of pedestrians. The information on route can be perceived tactilely by the pedestrian. Smets et al. [SBLN08] combined the use of a tactile vest for displaying the destination's directions with head-up and north-up maps. They conducted a study in a virtual environment where participants had to reach the given places as fast as possible. The results showed that an egocentric tactile cue could reduce the mental effort required for interpreting a north-up map so the completion times were on a par with those where a forward-up map was provided. Other tactile devices have been developed to convey navigational or spatially related information for mobile people, such as a wristband and a wearable tactile directional display by Tan and Pentland [TP97] or a vibrotactile vest by Rupert [Rup00].

The work of Chan et al. [CMM08] suggested that tactile cues could effectively convey background information in a visually dominated task. Nagel et al. [NCK⁺05] investigated if such tactile feedback could become an additional sense. After six weeks of wearing a tactile belt displaying north, participants from the experimental group showed signs of having the feedback integrated into their normal senses. Participants who had embraced the new technology reported a substantial change in their perceptions of the environment. Jones and Sarter [JS08] investigated as to when and how to apply the sense of touch for information representation. In [Erp05], two experiments for investigating the processing of spatio-temporal vibrotactile patterns by the torso were conducted. The first investigation regarding spatial acuity as a function of location on the torso showed a uniform acuity between 2 and 3 cm and a 1 cm acuity found on the body mid-line. The second investigated the effect of timing parameters in a localization task and indicated that localization performance was closely related to both temporal ordering and apparent motion. These results can be applied to optimize the design of presented information on a torso display. Marlo et al. [Loo81] investigated the accurate reception of tactile localization and messaging under physiological stress with the help of a tactile prototype display that used precision factors and the skilled placement of them. The cadets showed almost error-free performances, and the researchers concluded that the messaging and localization of tactile signals seemed to be unaffected by physiological arousal or stress.

The previous studies have indicated the fundamental work in the field of tactile user interfaces for the navigation of pedestrians and blind users. Researchers have encoded vibrotactile messages for the route guidance of pedestrians and blind users successfully. A tactile interface has also been used to present information to other types of users. In the next section, we discuss previous work on tactile user interfaces for pilots.

2.5.2 Tactile Displays for Pilots

In the previous research, tactile user interfaces have been used to display warning information to pilots. These tactile interfaces integrate into different forms to show the information in airplanes. Cardin et al. [CVT06] integrated a tactile display in the clothes of a pilot to decrease the attention needed for maintaining an aircraft's attitude and taking corrective action when the autopilot went off. The tactile interface sends vibrotactile feedback to the pilot when the aircraft goes off the balance. The system dynamically adjusts the position of actuators according to the sitting posture of the pilot to transmit the message. The results of the evaluations showed a slight improvement in the reaction times of pilots taking corrective actions. van Erp et al. [EGB06] investigated the effectiveness of a tactile torso display as a countermeasure to spatial disorientation. They investigated two important design parameters of the tactile instrument. The first is the coding of the rotation direction on the display. The second design parameter deals with the phase during which the tactile instrument should be active. van Veen and van Erp [VE01] investigated the use of a tactile channel instead of, or in addition to, the more common visual and auditory channels in the cockpit. They evaluated the perception of vibrotactile stimuli on the torso under high G-load conditions and found no significant impairment. Flytact [JWV⁺08], a tactile display, has been developed by the Royal Netherlands Air Force and TNO to provide information on ground speed and altitude during landings in degraded visual environments. The test results presented faster landings that were more accurate, better controlled and needed less mental effort when information was provided with FlyTact.

Thus, tactile interfaces have been found useful for indicating information to pilots. Tactile user interfaces have been used and perceived in the air as an additional channel of communication. They have also been investigated in vehicles on land, such as bicycles.

2.5.3 Tactile Displays for Bicycle Navigation

By investigating the navigation strategy of tourists on a bicycle trip, Pielot et al. [PPB09a] developed a tactile display for supporting the navigation of cyclists [PPB09b]. Instead of turning in different directions, they proposed a tactile compass that constantly pointed towards a destination selected by the cyclists in order to improve their senses of orientation. To realize this tactile compass, they attached two vibrotactile actuators to the handlebars, one at each end. These actuators then continuously conveyed short pulses that indicated the selected des-

mination's direction. The direction in relation to the way the cyclists were heading was encoded by the relative intensity in the vibration pulses: the stronger the vibration becomes on one side, the further the destination lies in the respective direction. In the future, the integration of tactile displays in cycles can be beneficial in bicycle-friendly tourist places. Tourists might be able to get tactile notifications for sightseeing without a non-visual or a non-acoustic display.

2.5.4 Tactile Displays in the Automobiles

A tactile interface is effectively used in Advanced Driver Assistance Systems on commercial scale e.g. in Citroen¹ and Audi² in the seat and steering wheel, respectively. Similarly, previous studies have investigated the feasibility of a tactile channel in the vehicle information systems e.g. in car navigation systems. A vibrotactile seat has been developed with the characteristics of a matrix with 6×6 elements with an interaction area of 430×430 mm with dynamically modifying haptic feedback based on the driver's sitting posture [RF09]. This seat can adjust according to the sitting posture of a driver for directional alerts. de Vries et al. [VEK09] designed a car seat fitted with an 8×8 matrix of vibrators and used it to code eight different directions. The results showed that tactile displays provided a favorable means of presenting directional information. A seat fitted with 24 vibrators in an 8×8 matrix [HVEK09] was then used to evaluate the ability of drivers to distinguish up to eight different directions. Distance information was presented by van Erp and van Veen [EV01] with a vibrocon (vibrotactile icon) for the three distance steps of 250 m, 150 m and 50 m. This information was presented to users by activating four tactile actuators under the left or right legs of the driver. The simulation results showed that the tactile interface helped reduce the visual burden of drivers. van Erp and van Veen [EV04] compared a tactile display with a visual display in a car simulator. The results showed that the tactile display reduced the cognitive workloads of drivers compared with the visual display, especially in high workload conditions.

A prototype steering wheel [KMH⁺09] has also been integrated with six tactile actuators to display the direction in a car simulator. The best driving performance was attained by combining a tactile display with a visual display or an auditory display. Vibrating steering wheels to indicate a lane departure are already commercially available, such as in the BMW 5 series car. We also now see vibrotactile

¹http://www.citroen.com.hk/tech/sec_04.htm

²<http://www.audiworld.com/news/05/naias/aaqc/content5.shtml>

interfaces to support secondary driving tasks, such as using a car navigation system. Different groups have integrated such navigation research prototypes into the steering wheels and into the seats of cars. "The Haptic wheel" was proposed by Hwang and Ryu [HR10], which was embedded with 32 actuators to present left and right alerts. This interface allows sending information through the skin of a driver's palm. Moreover, this interface provides information regardless of holding attitude. The results demonstrated that the interface was quite successful at sending directional alerts. In [MWCA⁺10], a tactile feedback device was added to the steering wheel. When the navigation system indicates a turn, the feedback device pushes the driver's finger towards the respective direction of the turn - either left or right. In the context of steering a vehicle, Verrillo has designed vibrotactile signals in an environment that is vibrating too, such as a car to avoid vibrotactile masking, e.g. by using different frequencies [VGCD83]. In [EAYM01], a steering wheel with inflatable pads fitted with a simple pneumatic pump was used to produce pulsations of varying frequencies on a driver's hand. The steering wheel can pulsate at different frequencies. This feedback reduces the reaction times of a driver for different tasks. Thus, haptic feedback was found to be useful for driver notifications and alerting in sensory overloaded conditions. Other research groups have concentrated on the analysis of how to encode information in vibrotactile simulations. By introducing the notion of tactile icons (Tactons), Brewster and Brown [BB04] offered a concept to systematically design tactile cues, and applied these to navigation systems [HBJ08, HB07]. To support the primary driving task, Ho et al. [HTS05] discovered that a presentation of vibrotactile signals on the torso supported a shift of visual attention towards critical visual driving events.

Tactile interfaces have also been investigated to display information in different areas. The presentation of information to soldiers is one of these areas. In the following, the previous work in this field is highlighted.

2.5.5 Tactile displays for soldiers

PeTaNa [VSE04b], a torso-based wearable system, was evaluated to present direction and distance information to soldiers in the field. This direction information was presented on the torso of the soldier. Distance was coded using a temporal rhythm on the vibration. van Erp et al. [EVJD05] experimented to investigate the usefulness of tactile displays with a helicopter and a speedboat.

The literature presents fundamental work in the field of tactile user interfaces. Similar to visual and auditory user interfaces, tactile user interfaces can be applied in communication between humans and machines in broad areas. It has been ob-

served that tactile interfaces are mainly used for displaying information to users. However, a tactile user interface is also utilized for entering information by users through a vibrotactile keypad [HBJ08]. The literature has shown sufficient fundamental work in the field of tactile interfaces for the route guidance of blind and pedestrian users but it still needs to investigate other applied areas. Research in the automotive area has shown proof-of-concept studies for displaying distance and direction information to drivers. However, previous research must still explore vibrotactile designs for displaying different crossings to drivers in complete navigation systems.

With our approach of a tactile based car navigation system, we are advancing the field in a few directions. Not only did we look at the presentation of single directions and individual turn instructions but also investigated a complete driving scenario with different types of crossings in urban environments. We left the lab and simulator environment and to run a set of experiments "in the wild" with a prototype system on the street. Beyond the actual navigation performance, we evaluated the perceptual/cognitive loads of car drivers on real road scenarios.

2.6 Car Navigation Systems

According to [Pla05], a route can be described as the connection of two or more locations which can be imagined or actually taken. In order to follow a route, i.e., to navigate to a destination, knowledge about the spatial environment and its network layout (e.g. streets, connections) is needed to make decisions about crossings. For new and unknown areas, drivers either make them aware of the network or count on the route guidance tools which provide the driver with information about the route in advance or offer step-by-step guidance while following the route.

Figure 2.6 shows that two types of route knowledge are available from origin to destination. *Survey knowledge* is directly pointing from origin towards destination regardless of streets and turns. This type of information usually provided by systems designed for the route guidance of pedestrians and blind users. *Route knowledge* provides detailed information regarding each turn to take from origin to destination. This type of information is provided by car navigation systems.

The car navigation systems are getting essential in the modern car industry. Three types of navigation systems are used in cars: (1) built-in systems offered by the car manufacturers, (2) navigation add-on devices offered by other companies and (3) navigation applications used in mobile devices. Therefore, users have the

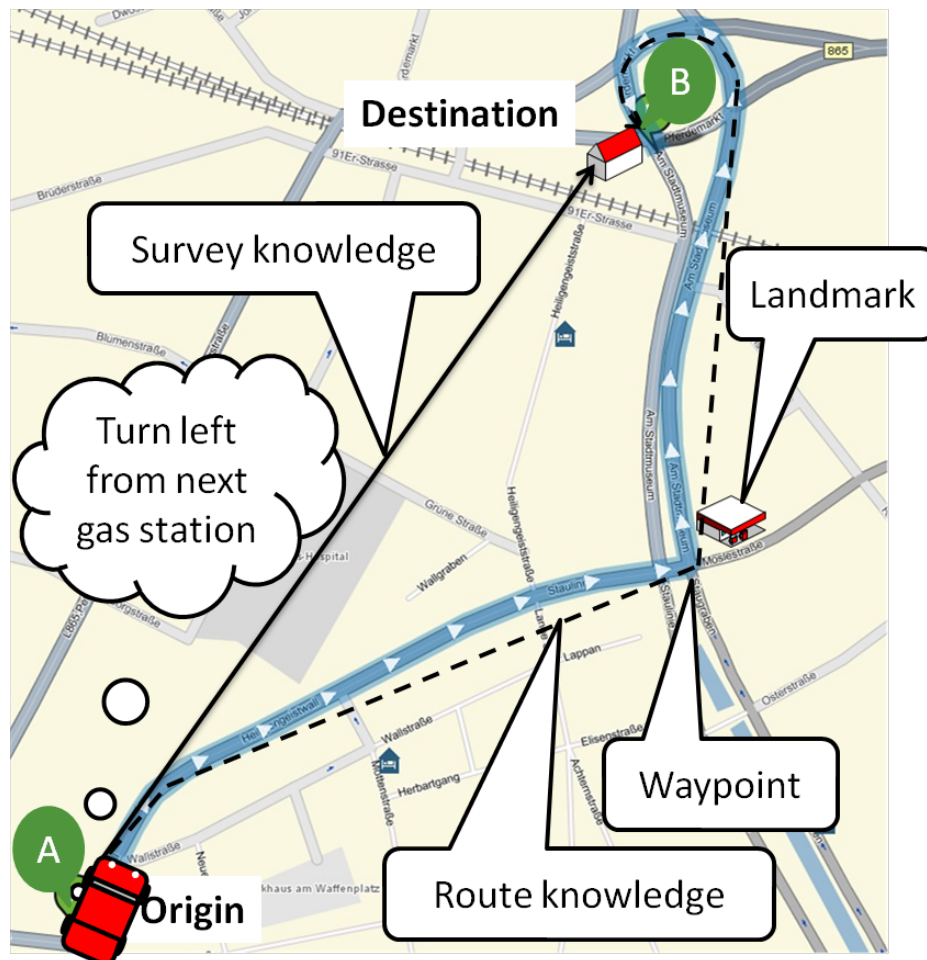

Figure 2.6: Types of route guidance.

freedom to select among the available choices. Some of the navigation systems are also cheaper than others. Ease of use and efficiency are dependent on the type of device being used.

Users process many steps in the navigation procedure. The navigation process is divided into four categories according to Downs and Stea [Pla05].

1. *Orientation*: Matching the cognitive map with the surroundings to know where a traveler is. The relative position of a traveler is determined in relation to the landmarks.
2. *Choice of the route*: The connection between the current position of a trav-

eler and destination is called the route. There can be multiple routes. Travelers select their routes based on many factors, such as speed, optimal for sightseeing, shortest route or via additional destinations.

3. *Keeping the right way*: To keep track of a correct route, the cognitive map is matched with the perceived environment.
4. *Discovery of goal*: The cognitive map is matched with the perceived environment to know if the destination has been reached.

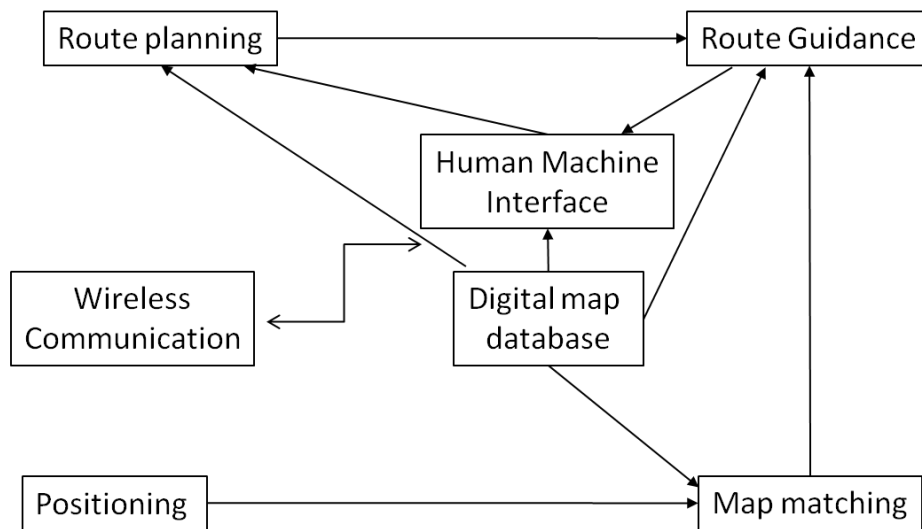

Figure 2.7: Modules of route guidance system proposed by Zhao in [Bur98].

Maps are the old-fashioned means of navigating in a car where a driver locates a route from the origin to destination on a paper. Currently, the car navigation systems are the most popular means of route guidance in cars. Researchers are investigating how to make car navigation systems more convenient for drivers. The basic modules of a car navigation system (see Figure 2.7) proposed by Zhao (1997) are discussed in [Bur98]:

- *Positioning*: In car navigation systems, positioning is provided by three technologies: (1) standalone (e.g. dead reckoning), (2) satellite-based radio (e.g. GPS) and (3) terrestrial radio. The individual use of these technologies does not provide positioning information accurately. The three technologies are often used in combination.

- *Map matching*: The errors that occur in positioning methods are often compensated with map matching methods. In this method, vehicles are positioned on a finite network of roads on a map. Different computer algorithms are used to make sure of the position of the vehicle on the road.
- *Digital map data base*: Different factors contribute to a map database such as the road network and its attributes e.g., road labels (streets), classes of roads (autobahn), address ranges, expected speeds, direction of flow, and construction sites. Banned networks are stored digitally.
- *Route planning*: Single or multiple routes are calculated from the origin to destination using this module. Different algorithms are used for the route calculation.
- *Route guidance*: This module guides drivers along a planned route. Two stages are involved in this module: maneuver generation and route following. Maneuver generation extracts information, such as crossing type and angles from the calculated route of the map. Timing and guidance instructions are decidedly based on the speed and distance from the destination in the route following stage.
- *Wireless communication*: Different wireless communication technologies are used to enable two-way communications between cars and external sources of information.
- *Human-machine interaction*: This module enables drivers to interact with car navigation systems. Different visual (e.g. screen), audio (e.g. speech interface) and haptic (e.g. buttons, rotary switches and keyboards) processes are used for interactions between car navigation systems and drivers. In this thesis, we emphasize this module to provide usable interactions between drivers and vehicles.

These modules are provided to make it easy for the users to fulfill their tasks successfully. There are four categories of tasks in the usage of car navigation systems [Gre96]:

1. Entering and retrieving destinations
2. Following the route guidance information
3. Retrieving other (but navigation-related) information

4. Calibrating/setting the system

Car navigation systems offer the freedom to select a route by calculating multiple available routes to a destination. While a driver selects any route, the car navigation system displays instructions on that route. The driver can estimate his or her current location in relation to his or her surroundings. One of the tasks of a car navigation system is keeping the driver on the right way. In case the driver missed any crossing on the selected route, the car navigation system recalculates an alternative route to keep the car on the right track towards its destination. On arrival, the driver will know from the street name and house number that his or her destination has been reached. Current car navigation systems help drivers by providing automatic computing functionality.

[Bur98] explained the functionality of a car navigation system to provide a turn-by-turn route guidance to a car driver. On each crossing, the route information is provided to a car driver using symbols or voice instructions. The system is programmed in such a way that it can choose how: information can be extracted from digitalized map, allocated between modalities, can be presented via available user interfaces. There are two approaches to present the navigational instructions via visual interface: (1) basic approach, and (2) junction-specific approach. In *basic approach*, a system has a collection of limited potential symbols. On each crossing, a system can choose the most suitable symbol to be presented based on relevant data, such as priorities, angles, and crossing types. In junction-specific approach, the portion of digitalized map (where car is located) is shown to a driver on screen. Also more information is provided with the help of arrows and other symbols which are drawn on the top of the map. In the current navigation system, both route knowledge / turn-by-turn knowledge and survey knowledge are presented depending on the situation of a car, such as stationary and dynamic conditions.

In [Bur00a], Burnett emphasized using landmarks for the presentation of turn-by-turn information in the car navigation systems. Landmarks are considered to be core components of a large-scale presentation and play an important role in the environmental learning process. The presentation of landmarks in the car navigation systems significantly improves usability. In [BNG99], Brooks et al. conducted an experiment to compare turn-by-turn displays with the route map displays. The results indicated that drivers glance at turn-by-turn displays 3.75 times more than they do at the route maps. Young women were similar to old men and young men were similar to older women. Drivers were found to rely on turn-by-turn displays but not on route maps for navigation purposes. Burnett et al. [WBMT01] com-

pared the use of distance within turn-by-turn direction presentation (i.e. turn left in 300 meters) with landmarks (i.e. churches) with regard to subjective aspects of usability. Drivers drove in familiar urban areas. They found relatively few looks with less duration towards navigation systems for the landmark approach compared with the distance approach. Drivers, however, made some navigational errors while using landmarks.

The fundamentals behind the implementation of computing technology in vehicles are: efficiency, enjoyment and safety [Sva04]. Efficiency is a matter of journey optimization. For the car navigation system to be efficient, the system should be able to save time compared with alternative methods. Skilled routing is another factor of efficiency so that the system will be able to quickly find a route alternative by avoiding congestion. Another factor of efficiency in the car navigation systems is the precise arrival estimation. Other activities such as pre-trip planning and the on-demand identification of a point of interest can be offered by efficient car navigation systems. Efficient car navigation systems should be able to reduce mileage by identifying road-works and offering dynamic traffic information. The last factor is saving money for users. Systems can consider all toll roads, ferries and charged congestion zones for route recommendation, so the users can save money. While travelling, the clear objective is to enjoy the journey by making it exciting, interesting, and instructive. The car navigation system should be able to create a richer travel experience. The system can provide a scenic route for open-ended journeys. For driving on fixed routes, the car navigation systems can provide points of interest, such as restaurants, shopping centers, and tourist attractions. Safety is the widely discussed objective of the car journeys. The first factor of safety is increased confidence which the car navigation systems need to provide. Car navigation systems are able to provide continuous guidance to make sure that the driver will never get lost. The second valuable factor of safety is decreasing frustration, simply by informing. These systems are able to provide notifications about the traffic problems, and thus can redirect the routes. The third factor of safety is decreasing driver workload compared with the traditional methods. The system acts as a secondary task and prevents distractions from the primary task. Some additional services can also be provided by the car navigation systems to monitor an inappropriate driving behavior and to warn about the violation of traffic regulations. Fundamental research has been carried out to improve different modules in the car navigation systems.

[EKC⁺97] compared three in-vehicle assistance systems: Ali-Scout, TetraStar and written instructions. Data were collected using GPS tracking systems, through self-reported user questionnaires and opinions. The results showed that the users

of Ali-Scout and TetraStar had many difficulties getting on the initial route and finding the destination once they were near compared with written instructions. The performances of drivers, however, improved with these systems as they became more experienced.

The car navigation system is a commonly used and very beneficial information system of the modern cars. The services and functionalities of a car navigation system allow facilitating for efficient car driving. An experience of using the car navigation system might become more exciting by reducing the information overloading from a driver. It is important not only to improve the functionalities but also the user interface of the car navigation system. For this, user interface part of the car navigation system should be explored for improving the car and user communication. In the past, the researchers examined the visual and auditory part of interface in the car navigation system but now other modalities are being studied such as tactile interface.

2.7 Discussion and Summary

Initially, this chapter explained the human sensory perception. The construction of the human eyes, ears, and skin is explicated in detail. How these organs are receiving the worldly information and transmit it to the brain. The next section discussed the environment and its factors. It explained how travelling is carried out during locomotion in the environment. Navigation is a fundamental part of travelling. It is important for a traveler to know his or her current position in relation to the environment for a successful navigation process. Different tools are used to support travelers in the navigation process, such as magnetic and digital compasses, maps, signs, and navigation systems.

Travelers use various means of transportation such as cars, airplanes and ships. Cars are most commonly used and privately available for individuals. Car drivers receive route information using the car navigation systems as well as their senses of vision and hearing. The type of navigation tool dictates what kind of functionality it provides. Various navigation systems provide both the visual and acoustic displays for the route guidance. The interference of the visual and auditory tasks might overload the car driver according to the multiple resources model.

Drivers need to perform primary, secondary, and tertiary tasks, such as driving the car, using in-car assistance systems and listening to infotainment systems using the visual and auditory channels. It is, therefore, difficult for a driver to manage all tasks in the available channels of communication. There is, thus, a

need to provide another channel of communication for a driver. In this thesis, we investigate a tactile user interface as an additional channel of communication in the car navigation systems.

Previously, a lot of research has been conducted in the field of tactile user interfaces for the blind and pedestrian users, cars, and airplanes. The tactile interfaces could be explored in the car navigation systems as a functional interface. In the remainder of this thesis, we explain possible scenarios for presenting vibrotactile information in the car navigation systems for the guidance of drivers. The last section of this chapter explained the detailed construction and functionality of the car navigation system. Among different basic modules, we investigate the human-machine interaction module in this thesis.

Chapter 3

Navigation Information Presentation on Urban Roads

When a person travels from one place to another place using a vehicle, he/she has to cross different types of road structure. On long car journeys, a driver passes through diverse types of landscapes and roads. Mostly, a car travels in rural areas and on motorways. Drivers drive faster on highways. This makes for a smooth traffic flow because of low populated areas. This kind of landscape is called "rural areas". The roads in such areas are referred to as "rural roads". By contrast, cars also cross populated and dense areas. When a car enters such areas, a driver sees many roads signs related to speed reduction. Mostly, speed in such areas is limited to 30 to 50 km/h. These types of areas are referred to as "urban areas". The roads in such areas are known as "urban roads". We designed the tactile based car navigation system for urban roads or environments. In urban areas, to reach from the origin to destination(s), a driver passes from many different: crossings, road types, speed limits, and traffic densities. On unknown urban roads, a driver needs the car navigation system very frequently. If a driver is able to get accurate navigation instructions, then the chances of forgetting the optimal way of destination is lower. This might save a lot of driving time. The pedestrians and traffic densities in urban environments are higher, so a driver requires a lot of visual and auditory attention to concentrate on the road. Thus, the urban environments are ultimate for designing the tactile based car navigation system.

In Section 3.1, we identify the different road intersections that exist on roads in urban areas. Furthermore, we explain each of these identified crossings as well as the need for information to be presented to a driver with the help of a scenario in Section 3.2. In Section 3.3, we discuss the requirements for designing

the interface for a car navigation system. Section 3.3.1 presents the scope of this thesis and research questions.

3.1 Urban Roads and Structure

Urban roads exist in residential areas, cities, and main highways. This covers small lanes and municipal roads of varying traffic densities up to larger ring roads and city express highways [HS05]. A road that is present in residential areas is referred to as a street. Similarly, main roads are routes joining the diverse areas of a city, and around a city center. Usually, the speed of cars on urban roads is 30 to 80 km/h. Because of the many different types of intersections, there is high variability in the speed of cars. Drivers usually use gear settings for speed reduction. At various times of the day, roads might become very dense or empty. A large proportion of cars exists among dissimilar types of traffic, such as trucks and buses on urban roads. The existence of cyclists is possible on varied urban roads. Besides cyclists, it is possible to see pedestrians crossing roads. A driver can expect a number of traffic lights during his/her journeys on these roads. There is a big variety in the lengths of these roads. Urban roads consist of diverse types of intersections.

An intersection is an area where two or more streets join or cross [Mas06]. The intersection includes all the pavement areas, the adjacent sidewalks, and pedestrian curb cut ramps. It is, thus, defined as encompassing all alternatives from turning lanes to the otherwise typical cross-sections of intersecting streets.

Road intersections usually have pedestrian and cyclist crossings, traffic signals, and high surfaces. The users of intersections include pedestrians, cyclists, motor vehicles, and buses. An urban road has four different types of intersections [Mas06]: (1) simple intersection, (2) flared intersection, (3) channelized intersection, and (4) roundabout intersection.

3.1.1 Simple Intersection

Simple intersections exist where two or more roads join together (see Figure 3.1a). They usually allow two-way traffic on a single lane road. These intersections can be constructed on both the major and minor streets, and used to maintain a typical

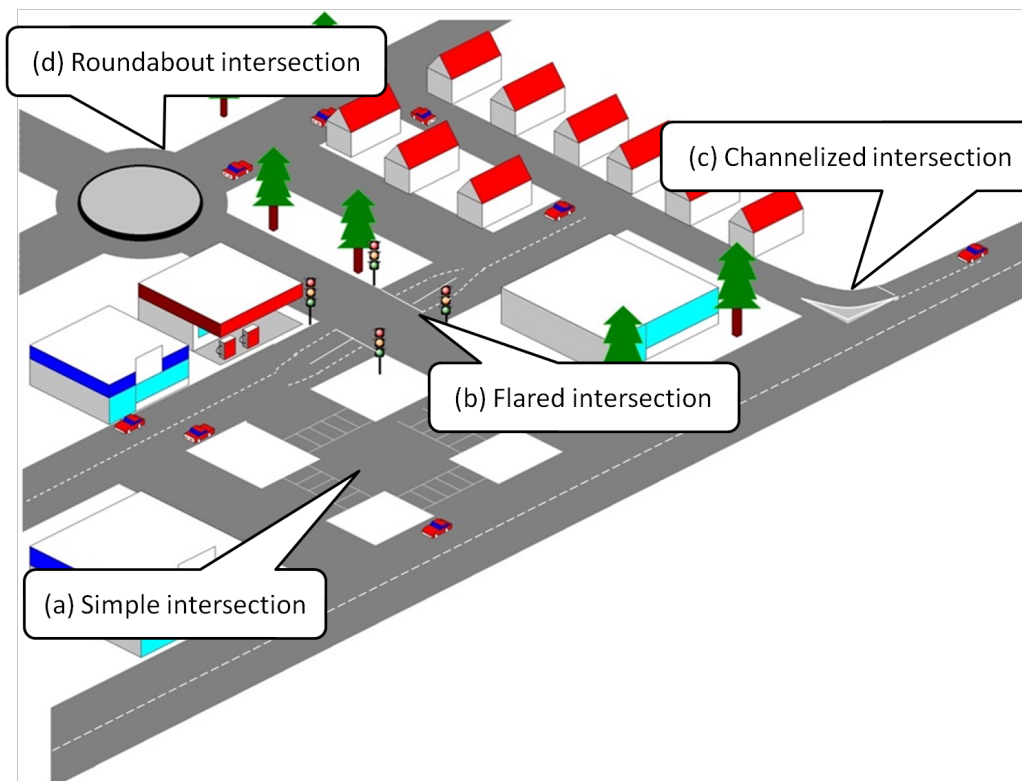

Figure 3.1: (a) Simple intersection, (b) flared intersection, (c) channelized intersection, and (d) roundabout intersection.

transaction of traffic. Simple intersections are usually present on streets with a lower amount of traffic flow. These intersections provide minimum crossing distances to pedestrians, and lower volume locations, such as residential streets. In such types, traffic can be controlled by signals or regulatory signs, such as "STOP" signs.

3.1.2 Flared Intersection

This type of intersection exists where it is required to expand the cross-section of a road (see Figure 3.1b). A road is divided into multiple lanes to allow the flow of dense traffic, and maintain safety. The lane is usually flared to lead the left turning vehicles away from the traffic stream in order to increase capacity in dense locations. These intersections are also useful to increase safety on higher

speed roads. The intersection might be flared to increase capacity and achieve the desired level of service. Flared intersections increase the walking distance and time of pedestrians.

3.1.3 Channelized Intersection

In channelized intersections, pavement markings or raised islands are used to designate the traffic path (see Figure 3.1c). Channelized intersections are frequently built for the right turns, usually with an auxiliary right lane. On intersections with curves, the island directs the drivers to and through the intersection. On very large intersections, islands are built to help pedestrians. Although channelized intersections are usually large, they can effectively reduce the crosswalk distance. Channelized intersections are also constructed at "T-type" intersections to guide approaching traffic to the right of the left turn lane.

3.1.4 Roundabout Intersection

Roundabouts are a kind of channelized intersection that allows one-way traffic flow around a circular path (see Figure 3.1d). Traffic control can be made safely and efficiently with the help of a roundabout. There are many different types of urban roundabouts:

Mini-roundabout: Mini-roundabouts have a diameter between 13 m and 24 m [Bri05]. This roundabout exists in average operating speeds of 60 km/h (i.e., low speed urban environments). The mini roundabout is constructed in those areas where usual roundabouts would hinder right of way constraints. These roundabouts are inexpensive in terms of space. The mini roundabout is perceived as being pedestrian friendly and usually recommended for low speed areas. The capacity of this roundabout is smaller than other types of roundabouts [RRSK00].

Urban compact roundabout: Urban compact roundabouts meet all the design requirements of effective roundabouts. This type of roundabout is pedestrians and cyclists friendly. It enables the pedestrians and cyclists to enjoy the safe and effective use of the intersection. Unlike mini roundabouts, capacity is not an issue on compact roundabouts. All legs of compact roundabouts have single lane entry that can easily accommodate a large vehicle [RRSK00].

Urban single-lane roundabout: Urban single lane roundabouts have single lane entry and exit on all legs. Those in Germany usually have a diameter of 26 m to 45 m. Circular islands cannot be crossed in such roundabouts. This design allows for slightly higher speeds on entry, circular path, and exit. The design of these roundabouts is similar in most European countries [Bri05, RRSK00].

Urban double-lane roundabout: The design of urban double lane roundabouts is similar to urban single lane roundabouts. Differences, however, exist in the width of the circular lane that allows the passage of two vehicles side by side. The circular path is not divided by a line. Thus, big vehicles are allowed to use both lanes to find their paths. Usually, there are two entries and exits in double lane roundabouts. It is important to drive at a consistent speed throughout the circular path. Cyclists and pedestrians have dedicated paths and side paths. The double lane roundabout is recommended in high volume areas of pedestrians and cyclists [Bri05, RRSK00].

In this thesis, we address the roundabouts with single entry and exit lane. This category of roundabouts includes mini roundabouts, urban compact roundabouts, and urban single lane roundabouts. These types of roundabouts are easily accessible in the urban areas where we can conduct evaluations and will further provide basis of more complex vibrotactile roundabout information.

3.2 Scenario: Navigation in the Car

Conventional car navigation systems are used to bring a car driver from one or more places to other places. We explained the functionality of the car navigation systems in Section 2.6 in more detail. [LPS⁺07] discovered that the presence of current car navigation systems reduced the number of accidents such that 12% drivers without navigation systems made damage claims as compared 5% with the car navigation systems. Car drivers using the car navigation systems are more alert and in less stress. In unfamiliar areas and destinations, the car navigation systems improve the driving behaviors and the performance of the car drivers. Car navigation system, such as TomTom reduced the workload of car drivers in unfamiliar areas [TNO07]. The usage of TomTom reduces the number of Kilometers in unfamiliar areas and destinations. Today's car navigation systems are using route knowledge or turn-by-turn instructions for the route guidance of the drivers. According to [MSS03] route knowledge is

" Knowledge of ordered sequences of locations, or landmarks, and actions to be taken at each landmark (e.g., go straight, turn right, etc.). Finding novel routes through a familiar environment has been thought to rely on survey"

Mostly turn-by-turn instructions are announced on the route calculated between the origin to destinations. The direction visualization between the two points is referred to as survey knowledge.

"*Survey knowledge* is knowledge of the spatial layout of landmarks defined in a common reference system" [MSS03].

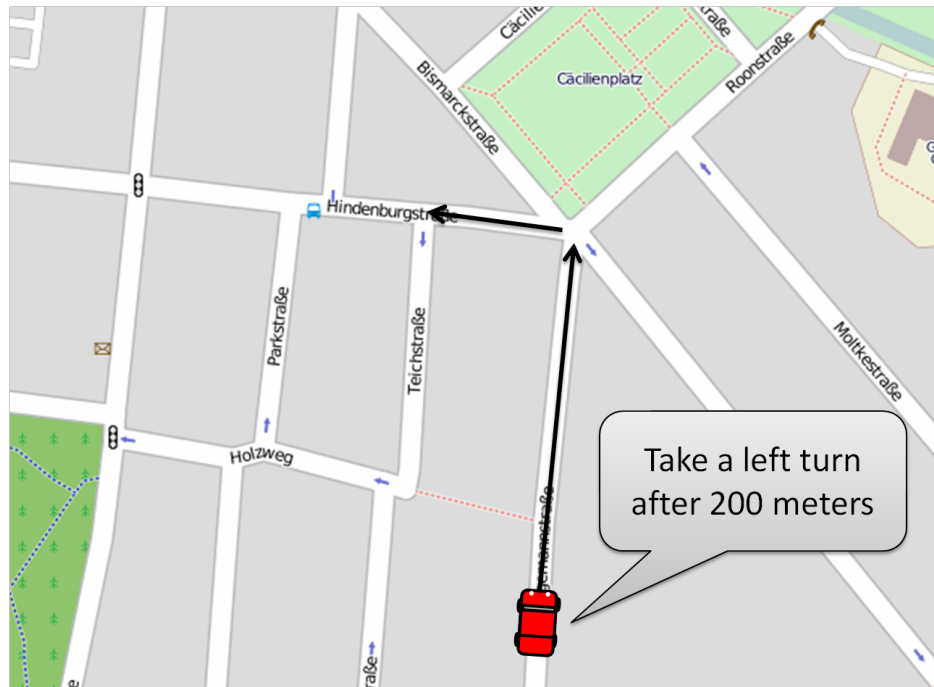

Figure 3.2: Route guidance on urban road.

Conventional car navigation systems often provide turn-by-turn route information to a car driver. Figure 3.2 shows that the car is following a certain route. In this case, the car navigation system has two channels of communication: visual and auditory. The driver is able to look either at a screen to know that he/she needs to turn at right after a certain distance using the visual channel. As a second option, the auditory channel provides route information in the form of voice prompts. The driver gets information, such as "take a left turn after 200 m".

In both cases of this scenario, we observe that two types of information are presented to a driver at certain crossings: (1) direction information, and (2) distance information. In designing car navigation systems, it is, therefore, required to explore how to present the direction and distance information on available displays. In the following, we define direction and distance in the context of space.

3.2.1 Direction

A direction is a signed angle between a variable line and a reference line [HT73]. The location of one element with respect to the other element is described as direction [Heu08]. Direction information can be presented in many ways. Usually, it can be described by referring to the some instance on that location. Direction can be described in direct and indirect ways. Direct information can be provided in person e.g. go straight and then take a left from "X" object, and this will be the destination. Indirect direction information can be provided on a map, e.g. if object "Y" moves straight from here to object "X", it will reach its goal. Both the direct and indirect description of direction can be more complex according to the number of curves or corners in a route.

It is easier to perceive direction from the closer objects compared with far objects. A person has the ability to recognize the direction of distant objects using visual and auditory perception. It is possible to estimate the direction of an object that is in the view of a person by using visual perception. Given the loudness of an object, as well as whether it is in sight or not, it is possible to perceive the direction of the object. The direction of the closer objects can also be perceived by touching them.

In the car navigation systems, direction is presented using both the visual and auditory channels. Visual displays use arrows or lines to continuously point the direction from the next crossing. They, therefore, use the indirect way of communication with a driver. The auditory display announces the direction from the next crossing in the form of voice prompts. In this case, the navigation system directly communicates with a driver.

3.2.2 Distance

Distance can be defined as how far away one object is in respect to another. The specification of the distance between two locations can use different units which are classified as absolute and relative measures [Heu08]. Absolute distance can be measured in units, such as miles or kilometers, e.g. town "A" is 100 kilometers

Type of intersection	Information required
Simple	Direction
Flared	Direction & distance
Channelized	Direction & distance
Roundabout	Type of intersection, number of exit to take

Table 3.1: Information required to display on different urban road intersections in the car navigation system.

away from the town "B". Relative distance can be measured in terms of time, e.g. object "A" is 3 hours way from object "B", or other measures, such as monetary measures, e.g. 4 Euros from here to place "B". Burnett [Bur98] cited from Downs and Stea that distance could be measured in three formats:

1. Absolute (in meters and miles)
2. Relative (e.g. halfway away compared with the distance between locations "A" and "B")
3. Costs (time "a few seconds far away", energy " a long way")

Car navigation systems usually present absolute and relative distances. The visual and auditory channels are used to display distance to a driver. The visual interface usually presents the absolute distance between a car and the next turn, or destination in a number format. The auditory interface also presents absolute distance in the form of voice commands, such as turn left after 300 meters. Relative and absolute distances can be presented with auditory announcements in combination, such as turn left after 100 meters, and then turn right after 10 seconds.

3.3 Requirements for Presenting Different Road Intersection Types with a Car Navigation System

The urban road consists of simple, flared, channelized, and roundabout intersections. While travelling on urban roads, a driver needs to cross these road intersections one or multiple times, depending on the road structures. A car navigation system presents a turn-by-turn information according to the type of the road intersection. On different types of urban road intersections, the information required

can differ. We made observations in order to identify the information required on different type of road intersections. Table 3.1 shows the information to be displayed on simple, flared, channelized, and roundabout intersection types. In the following, the information requirements for each type of road intersection are reported:

- On simple intersections, the car is only required to take a turn without changing lane. The presentation of direction information can, therefore, be enough to present this kind of road intersection in the car navigation systems.
- On flared intersections, the driver needs to know the direction to turn in advance, so he or she will be able to change lane. In case of taking in wrong lane, he or she might miss that turn. The presentation of direction and distance is, therefore, important on flared intersections.
- The traffic island on channelized intersection divides the road into two parts. Hence, it is important to present the route information in advance, so the driver will be able to get into the turning lane. On channelized intersections, the presentation of direction and distance information is, thus, required.
- Roundabout intersections are constructed differently to simple, flared, and channelized intersections. The driver needs to know that the car is going to enter the roundabout. The information regarding the "exit to take" is, thus, important to present, otherwise the driver can never get out from the circular path.

Section 1.1 discussed the motivation of our research problem, namely that the car driver is overloaded with excessive information coming from a multiple number of channels. In this case, a driver should concentrate on the tasks with more priority, such as observing traffic on the road. In the meantime, the car navigation system announces the directions, and the distances from turns on the way of the car. While performing a multiple number of tasks, a driver might fail to listen to an important instruction of a car navigation system. In our users studies, reported in [AHB09, AHB10, AB10, ABH12], and Chapter 5, we made observations of drivers, and conducted the interviews. On the basis of observations and interviews, we found that the user interface of the car navigation system should fulfill the following users requirements:

- The interface should be usable.

- The system helps bring a car driver from origin to destination(s) with no, or a least number of performance errors.
- A driver is able to perceive navigational instructions on all types of urban road conditions.
- The cost of the interface is comparable with existing interfaces in the car navigation systems.
- The drivers are able to perform visual and auditory primary and secondary tasks by using the interface. Also, it will not interfere with these tasks.
- The interface does not overload a car driver with too much information coming from different visual and auditory resources.

There are many situations when one modality is more suitable as a user interface as compared to other modalities. Cao [Cao11] discussed guidelines regarding the selection of visual, audio, and tactile modalities. These guidelines have been valid for decades for the design of multimodal information presentation, especially in automobiles. The usage of audio modality is very common in many information systems. According to the guidelines use *audio modality* when: the information is simple; short; will not be referred to later; deals with an event in time; calls for immediate action; must be detected independent of head position or eye gaze; the visual system is overloaded; the environment is too bright or too dark; and the user must move around. The visual modality is the most common user interface in available systems. According to the guidelines use *visual modality* when: the information is complex; too long; will be referred to later; deals with a location in space; does not call for immediate action; the auditory system is overloaded; the environment is too noisy; and the user can stay in one place. Current car navigation systems already use visual (screen-based) and auditory (speech interface) channels for displaying navigation information in the cars. There can be a problem of the visual overloading or noise or both when perceiving important navigation instructions. MRT [Wic84] suggested of using an alternative display in that context for the smooth flow of information, and to reduce excessive load. A number of emerging user interfaces might be deployed in the car navigation systems to reduce this problem, e.g. ambient, non-speech interfaces. These interfaces, however, have their own limitations for the presentation of navigation instructions in the cars. Ambient displays inherit the characteristics of visual displays. Subsequently, this interface is not appropriate in situations where

visual interfaces in navigation systems burden the driver. This is also true for other emerging interfaces that inherit the properties of visual and auditory displays.

We discussed the detailed construction and characteristics of the tactile displays in Chapter 2. Cao [Cao11] discussed further guidelines regarding the usage of tactile displays. We can also refer to these guidelines as the user interface requirements. The tactile modality can be used when:

- The task requires the alarming features of attention.
- The task is temporal in nature.
- The task requires hand-eye coordination where haptic sensing and feedback are key to performance.
- The visual and auditory channels of an operator are heavily loaded.
- The visual and/or auditory information is degraded. For example, the visual display possibilities are limited (e.g. in mobile-based navigation systems), or the auditory channel is unattractive (e.g. with music in a car).

In this thesis, we have suggested a non-visual and non-acoustic system, i.e. a tactile display for presenting navigation information on urban roads. Tactile interface is a different modality from other commonly used modalities. The sensation of touch and feel is different to vision and audio. It inherits the characteristics of neither the visual nor the auditory modality. According to the requirements of presenting the route guidance information to a driver, the tactile display fulfills the criteria of suitable interface. In a situation where visual and audio displays are hard to follow by the driver of a car, a tactile display could be appropriate for presenting information in the car navigation systems. The above guidelines show the suitability of the tactile display when the circumstances are not apt for vision and sound, e.g. when the visual and auditory channels of a user are overloaded. It is easier for a user to distinguish between information presented with a tactile display as compared to visual, and audio displays. The tactile display is an emerging interface of interest to many researchers as a complement to visual and auditory interfaces.

3.3.1 Scope of this Thesis

In our research, we explored different vibrotactile signals to present the navigation intersections to a car driver. In Section 3.1, we explained that the urban

roads consisted of many different types of road intersections: simple intersection, flared intersection, channelized intersection, and roundabout. The tactile based car navigation system is designed to present turn-by-turn route instructions on these diverse types of urban road intersections. There is no fully functional tactile based car navigation system exists which is able to present the various types of urban road intersections. Table 3.1 reported that the simple, flared, and channelized intersections types could be presented by displaying direction and distance information. On roundabouts additional instructions, such as exit to take is required for displaying the navigation instructions. In this thesis firstly, various vibrotactile signals are designed and evaluated to find most suitable signals for presenting the different types of urban road intersection. An experimental methodology is used to evaluate the varied vibrotactile designs. For our research, the experimentation is the most suitable method of evaluation because we can test the vibrotactile designs in real urban settings. We measured the quality of vibrotactile signals on the criteria of usability, performance, and driver's workload. We also conducted interviews and observations for collecting qualitative data.

After the design phase secondly, the prototype system is evaluated and compared with other car navigation systems in high visual and audio workload conditions in the real settings. In this thesis, we reported a number of experiments to solve the problem of designing a tactile based car navigation system. The settings of the experiments are much more controlled and realistic e.g., each evaluation is carried out in a real car and on the urban roads. Due to availability of the real cars for evaluations, we did not use a car simulator in our research. The results are more reliable in realistic scenarios. It was easy to find volunteers to take part in our user studies. For each experiment, we evaluated 10 to 14 participants, which is an acceptable sample size in the available time and resources among the research community. Our research methodology includes both quantitative and qualitative measures.

In the given resources, we are able to develop a prototype tactile based car navigation system. The system can be operated manually to provide navigation facilities. In design, implementation, and evaluation phases, the experimentation is done in real urban roads settings. Each session of the experiment was time taking, so we were able to conduct the evaluation on the roads of one city area instead of many cities. Due to time constraints, our samples sizes could not be increased to a large number of participants, but it is expected that large sample sizes might lead to similar results. Our findings can be applied to approximately all urban intersection types. The findings can help explore the tactile based car navigation system on the rural roads and motorways.

We integrated a tactile belt for displaying navigation feedback in the car. In the future, the tactile belt can be incorporated inside the seat-belt of the car for navigational assistance. Tactile displays already show different information in other parts of commercial cars. In previous studies, Kern et al. [KMH⁺09] integrated factors inside a steering wheel of a car to indicate the direction to a driver. However, the vibrotactile steering wheel has already been used for the indication of lane departure warning in Audi¹. Similarly, a vibrotactile seat has been used to show direction information in [EV01, HVEK09, VEK09]. Citroen² has, however, used a vibrotactile seat for the purpose of showing lane departures to a car driver.

The outcomes of our research showed that the tactile display for navigation information could be used along with other available user interfaces. The experimental methodology adapted for conducting this research provided us with a suitable design of tactile based car navigation system. We got a number of significant measures of evaluations that helped us develop our system, and would be beneficial for the automotive industry.

This thesis reports two main challenges in general: (i) design of vibrotactile signals, and (ii) evaluation of the tactile based navigation system. Direction, distance, and exit of a roundabout are the necessary information for designing the vibrotactile based car navigation system for the urban roads. First, on different urban scenarios, various tactile parameters are explored to find the suitable vibrotactile designs. Second, the tactile based navigation system is compared with the conventional system for performance in high workloads. Our prototype tactile based car navigation system fulfills the requirements of: road intersections types, users requirements, and user interface requirements reported in Section 3.3. This thesis explores the answers of the following research questions:

- Q1:** Which type of information is required to present with the tactile display for route guidance of a driver?
- Q2:** How to design and encode tactile messages to present identified information with the help of a tactile display?
- Q3:** How do the drivers perform with tactile-based navigation system in normal and high load conditions? Does this system help decrease the workload of drivers as compared to other modalities?

¹<http://www.audiworld.com/news/05/naias/aaqc/content5.shtml>

²http://www.citroen.com.hk/tech/sec_04.htm

In Chapter 3, we partially explore the answers to Q1. Chapter 4 investigates the answers to Q1 and Q2. The Section 4.2 searches the answers to Q1 along-with discovering the acceptability of the tactile displays in the cars. The Section 4.3 explores the possibilities of direction presentation with the tactile display by answering the Q1 and Q2. The vibrotactile presentation of distance information comes in Section 4.4 by answering the Q1 and Q2. The Chapter 5 answers the Q1 and Q2 for displaying the roundabout information with a tactile-based navigation system. All of above sections partially examine the Q3. The studies in Chapter 6 fully explore the answers to Q3.

3.4 Summary

In this chapter, we explored the characteristics of roads. We explained the rural and urban divisions of roads. We observed that the urban areas were more often populated with many pedestrians, cycles, and vehicles as compared with rural areas. For this reason, urban roads limit car speeds. They also consist of different types of the road intersections.

Nowadays, drivers use car navigation systems to navigate in the environment, in contrast to the paper maps of before. Car navigation systems have evolved from decades of research. Typically, they present turn-by-turn information to drivers. The navigation information presented to drivers consists of direction and distance depending on road intersections. On various types of road intersections, the navigation information required is different to direction and distance information. In the next chapters, we explore the encoding of tactile signals for presenting direction, distance, and roundabout information.

This chapter identified the type of information required to present in car navigation systems. We analyzed the challenge of bringing tactile interfaces into the car navigation systems. The direction of the problem is narrowed to make it solvable. This helps us design vibrotactile signals for specific scenarios that consequently provide enough information to a driver to navigate in the urban environment.

Chapter 4

Presenting Turn-by-Turn Information in Car Navigation System

In the past, the car drivers often used the maps and oral instructions to navigate in the environment. Currently, usage of the car navigation systems for the purpose of route guidance became very common among the drivers. The car navigation systems get popular because they are easy to use as compared to former methods of navigation. While traveling from the origin to destination(s), a car can take turns in different directions. It is important for a driver to know the direction to take turn in advance for the efficient navigation process. The spoken instructions in different languages guide the driver along the route. The information visible on screen of a car navigation system helps a driver in estimating a route from the origin to destination(s) and turn-by-turn orientation.

Pauzie and Marin[PML91] investigated that the aged drivers spent 6.3% and the young drivers spent 3.5% of their driving time glancing at the screen. Thus, the risk of visual distraction cannot be ignored in the visual displays. The auditory displays are, however, challenging in a noisy environment. Currently, the visual and auditory displays are primarily available methods of communication in the driving, a driver assistance system, and the entertainment systems. Hence, it is difficult for a driver to acquire visual and auditory information from the different car information systems, simultaneously. The possibility of failing in obtaining the navigation information is high for a driver along with the other driving tasks. So, we proposed an alternative medium of communication i.e. tactile display in the car navigation system.

Two types of information are important to demonstrate the turn-by-turn navigation [BP02, EVJD05]:

1. **Direction:** Location of the one object with respect to the other object is called direction.
2. **Distance:** How far the one object is located with respect to the other is called distance.

The information regarding the direction and distance of the next turn are important to present the turn-by-turn information in the automobiles [EVJD05]. It is common that a car navigation system displays distance from a particular landmark [Bur98, Pla05] to a driver for indicating a next intended turn in a certain direction. Furthermore, there are many other factors that might be considered for demonstrating the direction and distance information in the car navigation systems e.g. type of the road, location, speed, and traffic. Thus, considering these important factors in the design of the interface of a car navigation system might help in delivering the precise information and consequently, the navigation mistakes can be avoided.

In this thesis, we use the tactile belt [Heu08] for presenting the navigation information in the automobiles. In this chapter, we explained the encoding and design of the vibrotactile signals for displaying a turn-by-turn direction and distance information in the cars. The tactile belt exists in the form of a waist belt with integrated vibration components. The vibrators of the tactile belt formally spread around the abdomen body part of a driver. The vibrators vibrate in different manners to produce the vibrotactile signals. The tactile belt [Heu08] in Figure 4.1 is a prototype system, built with the help of a 90 cm long fabric tube. The vibrators, by Samsung SGH A400 size of 11 mm, are sewed inside the belt in a way that spread formally around the waist of a person. The vibrators are placed at the distance of 45 degrees from each other. A controller with integrated micro-controller in the form of box is used to operate that belt which runs with the power of batteries. It is observed that the vibration of the tactile belt is more announced in a sitting posture.

In our research, we explored the vibrotactile signals to convey the direction and distance information to a driver. The vibrotactile parameters explained in Chapter 2 can be modifying to produce different vibration patterns. A single vibration pattern can symbolize a certain message. This chapter investigates the tactile parameters necessary for displaying the direction and distance information



Figure 4.1: The tactile belt.

in the car navigation systems. We examined the acceptability of the tactile belt in the car navigation system. We identified the information necessary to present with the vibrotactile signals in the car navigation system. We explored the design possibilities for displaying this information with the tactile belt for the direction and distance information. The vibrotactile signals are investigated to convey the turn-by-turn information to a driver. We discovered an appropriate vibrotactile encoding for displaying the direction and distance information in the car navigation systems on different road intersections.

Structure of this chapter

Figure 4.2 presents the structure of this chapter. Section 4.1 illustrates the two scenarios of displaying the direction and distance information with the help of the tactile feedback on urban roads. In Section 4.2, we describe the survey examining the acceptance of the tactile belt in the car navigation systems. The Section 4.3 explores the tactile parameters suitable for direction presentation with the tactile display. The study compares the different vibrotactile encodings in order to acquire the suitable vibrotactile patterns for direction presentation. Section 4.3.1 tests validity of proposed vibrotactile designs for presentation of direction information. Section 4.3.2 depicts the evaluation of these vibrotactile designs in detail. In Section 4.3.3, we report the findings of our study dealing with the direction presentation. In Section 4.3.4, we discuss the answers to our research questions, and further findings of our study. The tactile parameters are unfold for distance presentation in Section 4.4. Section 4.4.1 inspects appropriate vibrotactile encodings to present distance information in cars with the help of a pilot study. The potential

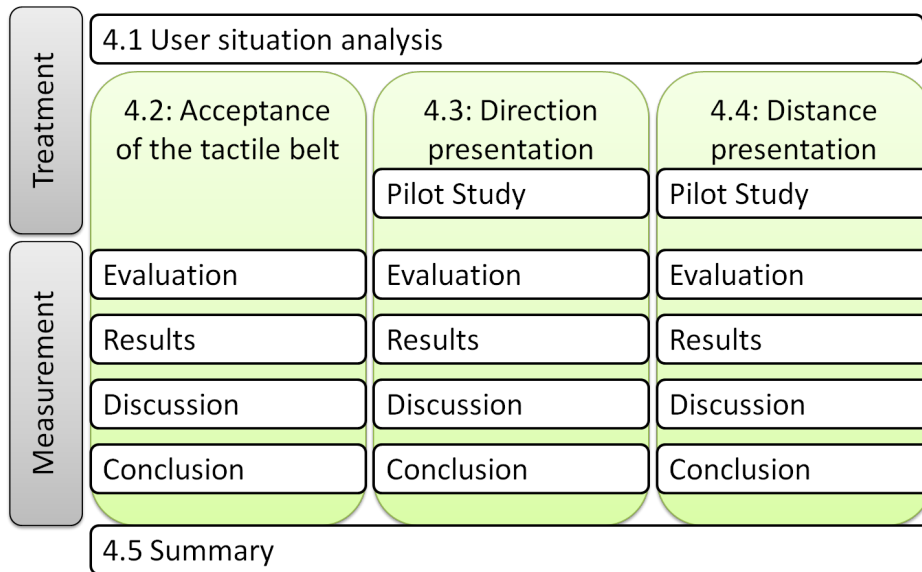

Figure 4.2: Overview of Chapter 4.

vibrotactile encodings for distance presentation describe in Section 4.4.2. Section 4.4.3 represents the experiment in detail that compared the different vibrotactile encodings for displaying distance information in the car navigation system. In Section 4.4.4, we report the findings of the experiment. In Section 4.4.5, we discuss the answers to our research question and further findings of our evaluation. We close this chapter by summarizing our work in Section 4.5. Parts of this chapter are published in [ABH12, AB10, AHB10, AHB09, BAH11].

4.1 User Situation Analysis

In this thesis, we used a tactile display for the route guidance of drivers. A tactile interface in the form of the tactile belt is utilized for displaying the direction and distance information to a driver. The conventional car navigation systems usually provide the turn-by-turn route guidance to a driver of a car. The presentation of the direction and distance of next maneuver [RMF⁺96] is among the most important tasks of the car navigation system. In this chapter, we use a tactile belt to provide the turn-by-turn navigation information to the drivers, by following approach of the traditional car navigation systems. For this, we presented two different example scenarios to convey the usage of the tactile belt for presenting

the direction and distance information in the car navigation systems.

Scenario 1: Presenting Direction Information

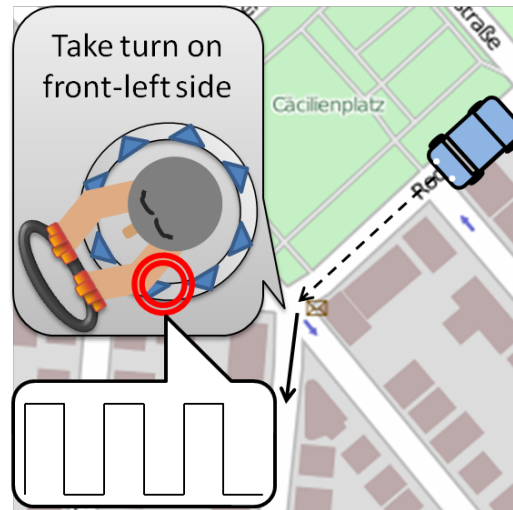

Figure 4.3: Three pulses of the vibrotactile signal on "front-left" side of the tactile belt indicate that the car is approaching the calculated crossing after covering the "far" distance.

Figure 4.3 depicts an example of the vibrotactile cues that are conveyed to a driver while approaching a crossing. The car presented in Figure 4.3 is approaching towards a crossing with five lanes. The lanes are directed towards cardinal and ordinal directions. The car is required to take the *front-left* lane from its relative heading from this crossing. In order to present the direction *front-left*, a front-left vibrator of the tactile belt will trigger on the respective side. The driver will feel the vibration and decide to take that lane. Following the scenario, the design of the tactile display for the presentation of direction information has the following requirements.

- Direction should be presented using the most suitable tactile parameter, which is easy to use for a driver.
- Vibrotactile messages must be easy to interpret and follow.
- Limited number of directions should be presented using the tactile display, given that an intersection does not have too many streets.
- Direction should be presented from the relative position of the car.

Scenario 2: Presenting Distance Information

Figure 4.4 presents the example cues that are conveyed to the driver through the tactile belt while approaching the actual turn. A left vibrator on the left hand side of tactile belt on the waist of a driver is triggered in order to convey the *left* direction. The vibration occurs in the form of different vibrotactile patterns in order to convey the distance information. According to on hand scenario, the vibrotactile patterns for the distance presentation should be designed according to the following requirements.

1. The vibrotactile patterns should be distinguishable for presentation of distance information.
2. The distance should be presented on the distinct positions of a car from a turn for the better perception of a driver. Because continues presentation of distance of a car from its relative position from incoming turn might be annoying for the driver.
3. The appropriate tactile parameters are required for the ideal understanding of the vibration signals.
4. The design should be usable for drivers.
5. Distance of next crossing should be presented from the position of a car.

The distance can be presented with the tactile display by following the previous work on distance presentation in the car navigation systems. George et al., [GGF94] divided voice messages in the car navigation systems in to the four classes "early", "advance", "prepare", and "at turn". Fukuda [FISH99] classified a level of crossing signs by their importance and by the appropriate distance for detection into "very far", "far", "near", and "very near". We found that the drivers do not prefer to acquire continuous presentation of vibrotactile signals for distance information in a car navigation system [AHB09]. The other solution is to present this information discretely. In order to present the relative distance of a car from the incoming crossing, it is required to divide it into discrete categories. We divided a relative distance of a car from the incoming crossing into four categories by following the approach of George et al. [GGF94], and Fukuda [FISH99]: (1) very-far, (2) far, (3) near, and (4) turn-now. The vibrator of the tactile belt is triggered in the form of distinct vibrotactile patterns, while a car approaches at

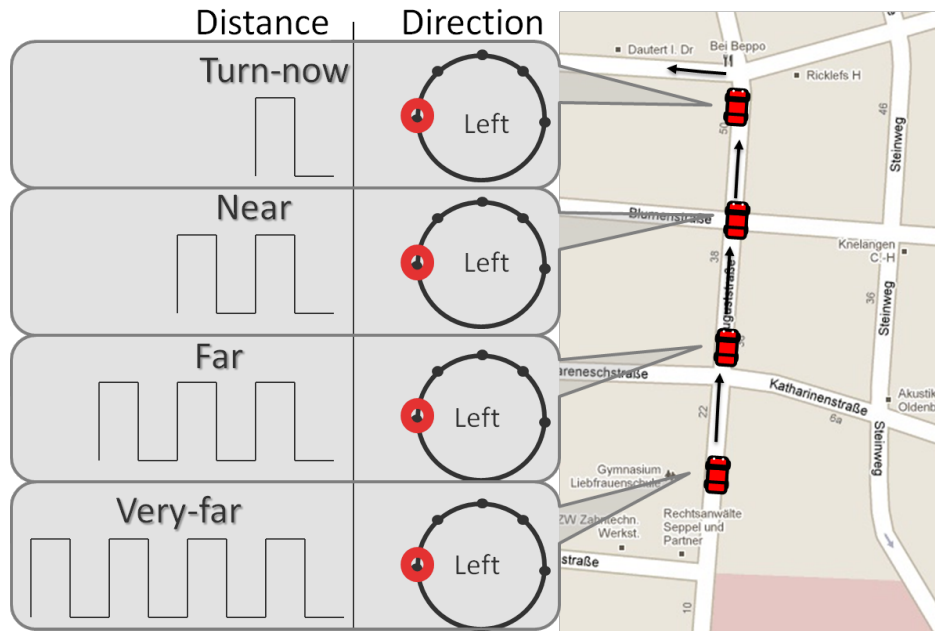

Figure 4.4: The direction and distance instruction presented by the tactile feedback, as the car approaches the crossing.

every above category of the distance. The driver makes turning decisions by following the vibrotactile instructions concerning the distance while approaching the crossing.

- **Very-far:** This category of distance will indicate the crossing where driver is required to turn his car. The driver will be able to determine for the incoming crossing.
- **Far:** This category of distance will describe that the car is approaching towards the crossing to take a turn. This helps drivers make driving decision in advance.
- **Near:** This category of distance will help driver to prepare for turn. The driver will be able to take some actions e.g. turn-on the indicator, change the lane etc.
- **Turn-now:** At this point, the driver is actually required to take a turn on a particular crossing. This is the final indication in the process of showing distance with vibrotactile signals.

In the above two example scenarios, we explain the presentation of the turn-by-turn direction and distance information in the urban roads. We discussed the requirements of designing the tactile display for presenting direction and distance information. The acceptance of the tactile display from the drivers of the cars is the matter to be investigated. The usage of the tactile feedback on real scenario for presenting the turn-by-turn direction and distance information triggered the following questions, in general.

1. Is the feedback of the tactile belt acceptable for navigation information in the cars?
2. Which of the tactile parameters are suitable for presenting direction information in the car navigation system?
3. Which of the tactile parameters are suitable for presenting distance information in the car navigation systems?
4. Is it possible to present the direction and distance information simultaneously without overlapping the tactile parameters?

In this chapter, we presented one survey and two experiments to answer the above questions. The survey describes the acceptance of the tactile belt in the car navigation system. The experiment-1 illustrates the design of vibrotactile encodings for presenting the multiple directions to the drivers. In the experiment-2, we explored the possible vibrotactile feedback for presenting the distance information. The designing would be discussed for appropriateness of the outcomes of the experiments for presenting the navigation information in one system.

4.2 Acceptance of the Tactile Belt in Car

A driver gets a lot of visual and auditory workload in dealing with the primary, secondary, and tertiary tasks in the car driving. In Chapter 1, we discussed the level of difficulty in dealing with in-vehicle task on a limited number of channels. A tactile stimulation as an additional channel could support the driving without using the visual or auditory sense according to the MRT (Multiple Resource Theory) [Wic84]. The navigation instructions play an important role to bring a driver to destination(s). Current car navigation systems are available with visual and auditory displays. We considered the tactile belt (see Section 4) for presenting the

navigation instructions in the car navigation systems. It is, however, required to examine the acceptance of the tactile belts in the car navigation systems. We have evaluated the acceptability of the tactile belts as one example of tactile user interfaces, for presenting directions using the TAM(Technology Acceptance Model) [Dav89]. In particular, the factors Perceived Usefulness (PU) and Perceived Ease of Use (PEoU) have been determined. Our hypothesis is "The tactile belt is acceptable for direction information representation in the cars."

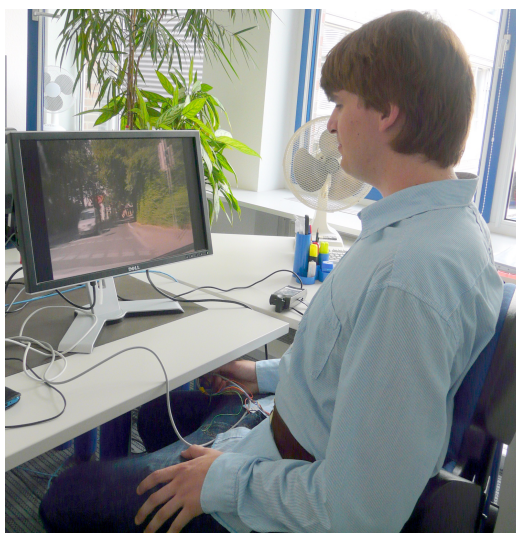

Figure 4.5: A pre-recorded route is played in front of the participant.

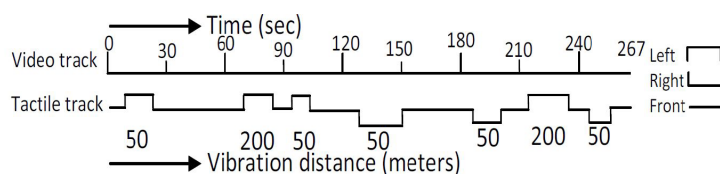

Figure 4.6: Synchronization of video chip with tactile track with the belt vibration distance.

4.2.1 Survey

Goal of our survey is to evaluate the acceptance of the tactile belt in the car navigation system.

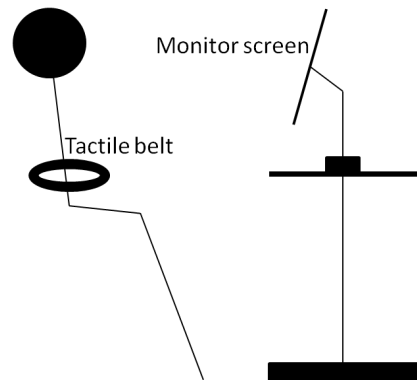

Figure 4.7: Survey setup.

Participants and Apparatus

Fourteen participants i.e. 3 females and 11 males, belonging to 18 to 40 years age group have taken part in the survey. We have used a tactile belt with six vibrators to present the front, right, and left directions in the driving simulation. We used a TAM questionnaire [Dav89] for data collection.

Procedure

The participant was first asked to provide the demographic information. The tactile belt was worn by the participant. The front direction was presented by simultaneous activation of the two vibrators situated in the front-left and front-right of the belt. The stimulation on the right and left side represents upcoming right and left turns respectively. Front, right and left vibrators continuously display directions until a crossing is reached. Duration of the right and left vibration is calculated as: on small routes, a vibrator is activated 50 meters in advance, and on the main routes, 200 meters in advance. In the survey, a video of 267 seconds of a pre-recorded route (see Figure 4.5) was presented to the participant, and synchronized with the tactile stimulation indicating the turns shown in Figure 4.6. The evaluation situation is symbolized in Figure 4.7. The route was composed of different turns on smaller streets and main roads of a city. In the end of evaluation, participants asked to fill out a questionnaire which is designed according to scale proposed by Davis [Dav89]. The whole session took around 15 minutes for one participant.

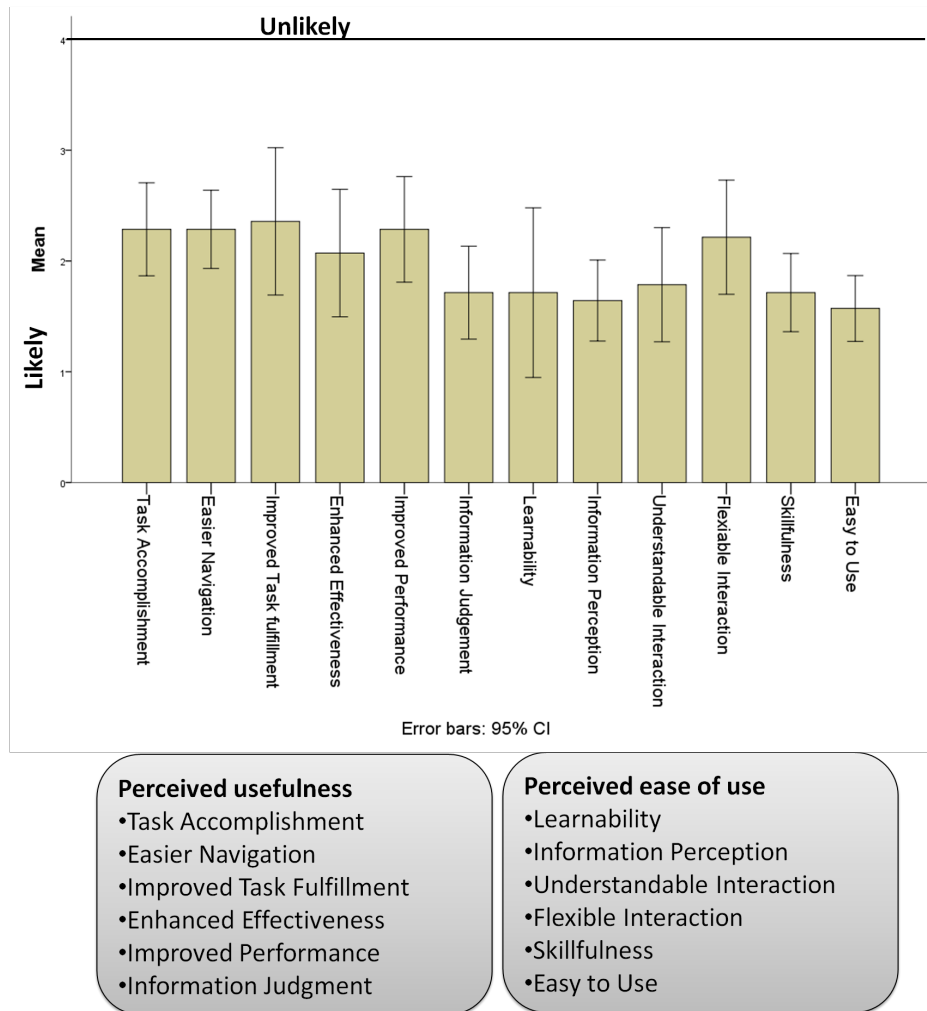

Figure 4.8: Results of perceived usefulness and perceived ease of use.

4.2.2 Results and Discussion

Figure 4.8 shows the calculated means of responses of the participants. According to the calculated means of responses, all factors of PU and PEOU fall under scale of 4 which is 'Quite Likely'. The one-sample Wilcoxon signed rank test found the factors of PU and PEOU significantly acceptable for the participants $p < 0.05$. This shows the participants' acceptability to the tactile belt for the directional information presentation in automobiles. Results show learning, usage, and interaction of

the tactile belt is more acceptable factors among all. According to oral responses of the participants, they prefer to use the tactile belt as an integrated feature for the directional information over visual and auditory interfaces, but demanded to provide visual map for showing the full route. Participants feel irritated with continuous direction information, especially for the longer trips. They desired to have vibration of the tactile belt as controllable feature because probability of messing vibration information with the vibration of the car. Distinct information needs to present with different frequencies patterns.

So, the tactile belt is acceptable interface for the navigational help in the cars. This study provides some design ideas of developing the tactile based car navigation systems e.g. the drivers' preference for discrete vibrotactile patterns. This study provides the initiative in the development of vibrotactile based car navigation system.

4.3 Direction Presentation with a Tactile Display

Direction is one of the most important measures for presenting navigation information on different road intersection. In this section, we described the design of vibrotactile encodings for presenting different directions from relative position of a car to the driver. In the remainder of the chapter, we use the term *direction presentation* to refer to the presentation of different directions with the tactile display. There are two types of direction i.e. the cardinal directions and ordinal directions [VEK09]. The cardinal directions are "north", "east", "west", and "south". Furthermore, ordinal directions are "north-east", "north-west", "south-east", and "south-west". In Figure 4.9, the vibrators are located on *front*, *front-left*, *left*, *front-right*, *right*, *back*, *back-left*, and *back-right* positions around the waist of a driver. In this thesis, we use the terms "front", "front-left", "left", "front-right", and "right" relative to the front side of a driver. We assumed that "back", "back-left", and "back-right" positions are not needed in common driving scenarios. de Vries et al. [VEK09] showed that the drivers can distinguish eight different levels of directions with the tactile display. In this study, we encoded up to four different levels of directions (left, front-left, right, front-right). We considered four levels of directions for vibrotactile encoding due to the fact that they frequently occur in a realistic urban scenario. According to Brewster [BB04] frequency, amplitude, waveform, duration, rhythm, and body location are tactile parameters that can be modified to present information via tactile user interface. The body location is best suited to present direction information [VEK09, HVEK09, Heu08, PHHB08]

among tactile parameters [BB04]. In our study, we compared four types of encodings to present the direction information: (1) *block design*, (2) *one vibrator design*, (3) *two vibrators front design*, and (4) *two vibrators side design*.

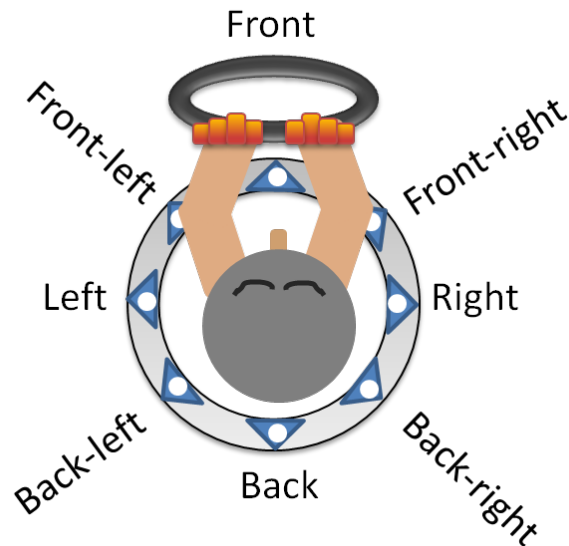

Figure 4.9: Locations of different vibrators on the tactile belt showing eight directions to a driver.

1. de Vries et al. [VEK09] proposed a bar and *block design* with the tactile seat to present direction information to the driver. In the block and bar designs "front-left" and "front-right" directions are presented by activating 9 vibrators on the front-left and the front-right side of the seat respectively. In the bar design, 24 vibrators on the left and right side of the tactile seat are activated to convey "left" and "right" directions. In the *block design*, the "left" and "right" direction are presented by activating 6 vibrators on the left and right side of the seat respectively. In order to present direction information, the vibrators of the seat are activated with inter-stimulus intervals of 125, 250, and 500 Milliseconds. In our study, we encoded "the *block design*" of de Vries et al. [VEK09] with the tactile belt by activating one vibrator on respective side depicted in Figure 4.10. The belt vibrates with inter-stimulus intervals of 125, 250, and 500 Milliseconds. The advantage of our design is that it utilizes only one vibrator to present direction as compared to multiple vibrators in the *block design*.

2. In *one vibrator design*, the front-left vibrator activates in "front-left" direction of the tactile belt to convey that direction. The front-right vibrator of the tactile belt activates in respective direction to convey "front-right" direction. The left and right vibrators of the tactile belt activate to present "left" and "right" directions respectively. The design is described with the help of Figure 4.10. The vibration occurs on different distances from a desired crossing by following the approach in [AHB10] which is explained in Figure 4.4. The details regarding distance presentation are explained in Section 4.4.
3. In *two vibrators front design*, two vibrators activate simultaneously to present direction information. The front and front-left vibrators are activated simultaneously to present "front-left" direction as depicted in Figure 4.11. The front and front-right vibrators activated simultaneously to present "front-right" direction. The left or right vibrators of the tactile belt presents "left" or "right" directions respectively. In this design, the vibrators are triggered using vibrotactile distance patterns shown in Figure 4.4.
4. Similar to the previous encoding, two vibrators are activated simultaneously to indicate direction to a driver. The left vibrator of the tactile belt is activated to present "left" direction in this design. The vibrator located on the right side of a driver's waist presents "right" direction. In *two vibrator side design*, the left and front-left vibrators of the tactile belt are activated simultaneously to show "front-left" direction as shown in Figure 4.12. Furthermore, the vibrators located on the right and front-right location of the tactile belt presents "front-right" street. In this design, the vibrators are activated using vibrotactile distance patterns in Figure 4.4.

We compared these vibrotactile designs in a pilot study to examine their appropriateness. All the four designs were compared on real urban roads in real cars. The following section describes the details of the pilot study.

4.3.1 Pilot Study

The tactile parameter of body location is used to encode the direction information. It is described in the previous section that the direction can be presented in different possible ways. On the basis of a brainstorming session, we have come up with four different possible vibrotactile designs for the presentation of direction information i.e., *block design*, *one vibrator design*, *two vibrators front design*, and

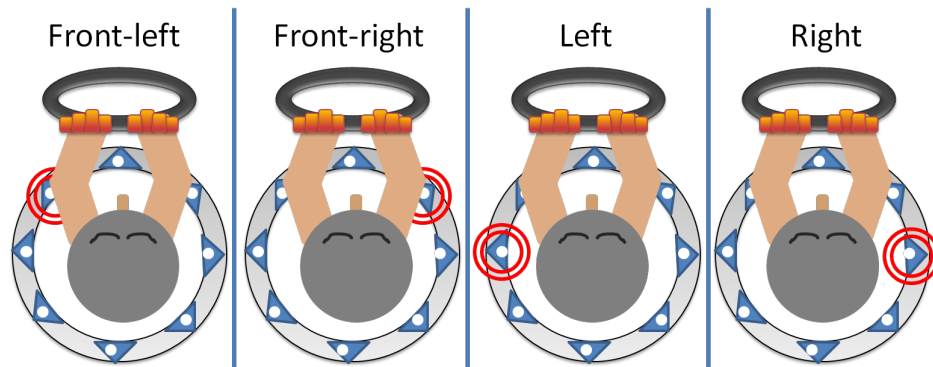

Figure 4.10: One vibrator design (block design): One vibrator on a particular side is activated to present the respective direction.

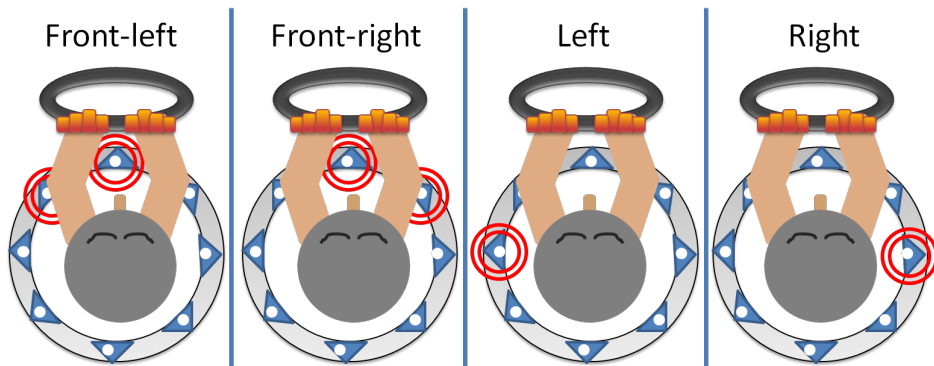

Figure 4.11: Two vibrators front design: The front-left or front-right vibrator is activated to present a particular direction.

two vibrators side design. We are required to test the validity of proposed vibrotactile designs to present direction information to a driver. For this purpose, we conducted a pilot study to determine the validity of vibrotactile direction encoding with our tactile belt for further evaluations. We measured the performance of a driver on these designs and observed other aspects, such as safety and distraction of the driver. We evaluated the *block design*, *one vibrator design*, *two vibrators front design*, and *two vibrators side design*. The pilot study investigates the specified questions:

1. Does the presentation of distances with direction help decrease the error in interpreting the information?

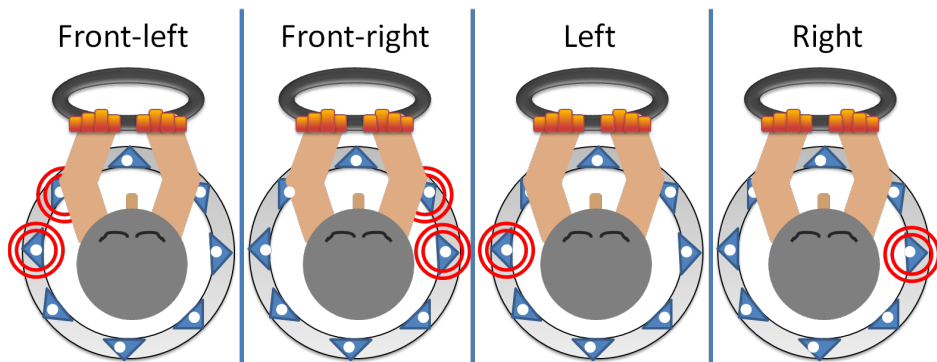

Figure 4.12: Two vibrators side design: The left and front-left vibrators or the right and front-right vibrators are activated to present a particular direction.

2. Which vibrotactile information design among the *block design*, *one vibrator design*, *two vibrators front design*, and *two vibrators side design* is more helpful for the driver to achieve the best performance?

Participants and Apparatus

We recruited 3 male participants with an average age of 29 years ($SD \pm 6.00$). All participants held on average of 11 years ($SD \pm 6.00$) of driving experience.

The tactile belt was used to provide navigation aid in all driving sessions and the voice of the participants was captured during the experiments. We have conducted an interview at the end of each session with the participants.

Design and Procedure

Our pilot study contained one independent variable i.e. turn-by-turn directions and distances are presented to the drivers with vibrotactile signals. We compared four different vibrotactile encodings in the four sessions of driving for displaying the spatial information to the drivers. Each participant drove with the help of 4 different designs on an urban road. We measured the error rate of drivers' recognizing the correct direction for every vibrotactile signal. On each crossing, the wrong interpretation of the direction by the participant was considered as a direction error. Additionally, we interviewed the participants about their preferences of vibrotactile encodings after the experiments.

The participants wore the tactile belts around their waists. We trained all the participants for each of the 4 different vibrotactile encodings and instructed them

to think aloud regarding the directions while driving. The experimenter seated next to the driver was controlling the *tactile spatial display*. The participant was following the route according to the vibrotactile instructions and announcing aloud the different directions.

We changed the order of the four tactile encodings for each of the participants to avoid learning effects. Before the first session, we trained the participant on the first vibrotactile encoding in the sequence. After completion of the first driving session, we interviewed the participant regarding the design. We repeated the same sequence of steps for the other designs. Each of the participants drove 4 sessions on 4 different vibrotactile encodings in a real urban environment.

For each design, the participants drove on the average 37 crossings ($SD \pm 0.82$). Each test session took around 20 minutes including the training, the driving and the interviewing.

Results

In this section, we present the quantitative results showing the errors made by the participants in interpreting the direction information and qualitative results representing the design preferences of the participants.

Errors in perception of the direction: The participants were able to interpret all vibrotactile signals of the *tactile spatial display*. They were able to correctly recognize all directions in the *one vibrator design*. In the *two vibrators front design*, the participants were often identifying front-right as a right direction. The participants made errors of identifying left as front-left, front-left as left, and front-right as right direction in the *two vibrators side design*. In the *block design*, the participants made mistakes of identifying left as the front-left and front-right as the right direction.

Qualitative Results: We collected the qualitative data from the interviews. The participant liked the tactile display on crowded road "Having vibration on torso is quite good in situations where a lot of pedestrian and distraction otherwise, and it worked well." All participants preferred *one vibrator design* over all the designs for the *tactile spatial display*. In the following, we report the feedback of the participants on each design.

Direction perception: The participants of the pilot study were sure that they made no errors in perceiving directions using *one vibrator design*. In all other designs, the participants think that they made 2 or less mistakes in the identification of directions.

	Left	Right	Front-left	Front-right
One vibrator design	0%	0%	0%	0%
Two vibrators front design	0%	0%	0%	20%
Two vibrators side design	5%	0%	25%	60%
Block design	5%	0%	0%	33%

Table 4.1: The percentage scores indicate errors made by the participants to identify the directions in all designs.

Need of distance presentation: The participants stated that it is very important to present distance. "It is very important to have distance presentation because you need to prepare for turning, so it is really important to be informed in advance." The presentation of information in *block design* is dangerous for the driving safety. "At one point, I had to stop hard which was certainly dangerous and at one time, I even missed the crossing." "It is very important to receive information right before the turn and with fuzzy GPS, the information presentation of *block design* will not work."

Need of an additional display: One participant did not need any additional display with the tactile display. The other participants required the visual display with the tactile display.

Activation of two vibrators: Simultaneous activation of two vibrators for the *tactile spatial display* was not liked by the participants. "Simultaneous activation of two vibrators was quite confusing for me and hard to distinguish." It was difficult to differentiate the two adjacent directions. "It was difficult to feel front-left and front-right in *two vibrators side design*." "Two tactons have strange feedback."

One vibrator design: The participants preferred the combination of one vibrator with distances. "It is nice, I like it – It is helpful to have additional distance presentation and not distraction like *two vibrators front design*, and *two vibrators side design*." "It is better and easy to understand." "It is easy to understand and perceive."

Discussion

The results provide us the proof-of-concept that the tactile belt is helpful to convey multiple directions and distances. With no errors, the participants verbally

reported that they feel confident in using the *one vibrator design*. So, the findings of our pilot study supports the *one vibrator design* presentation, specially with the quality of distances presentation.

Distance presentation: The results showed that distance presentation increased the accuracy of information perception. The qualitative results showed that in the *one vibrator design* the participants felt more confident and secure as compared to the *block design*.

Performance: It is difficult to decide between *one vibrator design* and *two vibrators front design* on the basis of the quantitative results. Although we conducted this study with only three participants, but observations and comments of the participants helped us a lot to know the pros and cons of the designs.

In the *block design*, the drivers were getting information once before the crossing. They found it dangerous for the safety of driving. Because they do not receive any warning signal regarding the incoming crossing, and get confused when they perceive direction information suddenly at once. So, it was difficult to make sudden driving decision when they were not already prepared for it. We cannot choose between *one vibrator design*, *two vibrators front design*, and *two vibrators side design*, because the drivers performed similar on all the designs.

We conducted this study with all male participates; so gender was one of the limitations of the study. We conducted the study in the urban environment, so we were not certain that the designs could be applied to other scenarios e.g. motorways.

We are required to conduct further evaluation with more number of participants to find one appropriate design among *one vibrator design*, *two vibrators front design*, and *two vibrators side design*. For this, we evaluate the designs on performance, usability, and cognitive workload.

4.3.2 Evaluation

A tactile belt was developed by Heuten and colleagues [HHPB08] for the route guidance of blind users, and pedestrians. Afterward, we investigated it to present the direction information to a driver in the pilot study. The purpose of the pilot study is to compare different vibrotactile designs: (1) "one vibrator" design, (2) "two vibrators front" design, (3) "two vibrators side" design, and (4) "block design".

The pilot study was performed with three male participants. The drivers had to drive on four different routes for the evaluation of the four tactile encodings of direction presentation. The drivers were thinking aloud and interviewed after each

driving session. However, the design and results of the study did not help conclude an appropriate vibrotactile encoding for the direction presentation. In this study, we aim to overcome the limitations of the study by increasing the number of participants for the validity of results, and findings a significant difference in the performance of the drivers for the selection of appropriate vibrotactile design. We aim to evaluate different vibrotactile designs on usability and workload as a usable interface makes the interaction easier that might reduce the workload of a driver due to a limited number of channels, and increases the performance. In this section, we present an experiment that investigates different configurations named as *one vibrator design*, *two vibrators front design*, and *two vibrators side design* for direction presentation via vibrotactile interface. We tested the vibrotactile configurations with respect to the above stated criteria of performance, usability, and workload of a driver.

The goal of this study was to explore the appropriate vibrotactile signals to present the direction information to a driver in a real urban environment with the tactile belt. The conditions of our evaluation to present comprehensible vibrotactile signals that are usable and do not impose additional workload on a driver. The final vibrotactile display will be simple and usable for the drivers. In the following, we present the research hypotheses based on the pilot study:

H1: The participants can perform better on the *one vibrator design* than the *two vibrators front*, and *two vibrators side* designs.

H2: The *one vibrator design* is more usable than *two vibrators front* and *two vibrators side* designs.

H3: The *one vibrator design* imposes less amount of workload on a driver than *the two vibrators front* and *two vibrators side* designs.

Experiment Design

The independent measures of our experiment are the presentation of directions, such as right, front-right, left, and front-left to the participants with three different vibrotactile designs. We presented the three vibrotactile designs to provide the navigation information to the participants in the three singular driving sessions. In the driving sessions, three different vibrotactile conditions i.e. the *one vibrator*, *two vibrators front*, and *two vibrators side* were presented. The approach of the experiment was within subject. In the within subject approach, one participant is involved in all the conditions.

Dependent Measures

We selected the dependent measures of performance, usability, design ranking, and workload, considering the hypotheses from H1 to H3. In the following, we explain the details of our dependent measures.

Performance on different vibrotactile configurations: The perception of the vibrotactile stimuli by the participants were recorded and evaluated for the measurement of their performance. The participants were thinking aloud the meaning of the each vibrotactile signal. The performance of the participants was measured by recording their errors in interpreting the vibrotactile signals in each configuration.

Usability: The usability of the user interface was measured by the system usage frequency, complexity, ease of use, support from technical person, integration, inconsistency, learnability, cumbersome to use, confidence, and practice.

Ranking: Each participant ranked the *one vibrator*, *two vibrators front*, and *two vibrators side* designs on "most preferred", "preferred", and "least preferred" scale. The ranking have been done after completing all driving sessions.

Workload: The workload is measured on the basis of mental demand, physical demand, temporal demand, performance, effort, and frustration level.

Participants

We conducted the evaluation with 10 participants, 3 females and 7 males. The average age of the participants was 29.6 years ($SD \pm 3.8$). The participants have on average 11.8 years ($SD \pm 4.23$) of driving experience. Each of the participant completed total 3 driving sessions for 3 different vibrotactile encodings. We conducted the driving sessions in the morning and afternoon time slots. We conducted the evaluation on urban busy roads, so they were commensurably busy in both time slots.

Apparatus

We used Volkswagen Golf and Passat cars during the evaluations. We used the tactile belt (see Section 4) as user interface for our evaluation.

The belt is connected via serial port to the laptop of experimenter. The experimenter controls the functionality of the tactile belt during the experiment sessions. An open source program CamStudio¹ is running on the laptop of the experimenter.

¹<http://camstudio.org/>

So, the experimenter is able to record the given vibrotactile signals along with the voice of a driver. Later on, the experimenter can analyze that if the driver identified the vibrotactile signals correctly, by matching the voice of driver with the tactile signals.

We used the SUS (System Usability Scale) [Bro96] and Nasa TLX [HS88] questionnaires for measuring the usability of the system and workload of a driver respectively. The experimenter conducted the interviews at the end of each driving session for the collection of qualitative data, such as distraction, confidence, identification of information, and need of additional interface and further suggestion on vibrotactile encoding.



Figure 4.13: The driver wearing the tactile belt.

Procedure

First, we explained the three different vibrotactile encodings for the direction presentation to the participant. We randomized a sequence of the *one vibrator*, *two vibrators front*, and *two vibrators side* designs to reduce the learning effects. The participant was asked to read the instructions and signed the permission of recording voice and capturing photos.

The participant wore the tactile belt and learnt the three designs. We instructed the participant to drive to the venue (i.e. starting point of the selected route for

evaluation) and stop for a while at a free parking lot. We reminded the participant of the first vibrotactile encoding in the sequence and instructed to drive. We used a Wizard-of-Oz approach in the experiment. The participant was instructed to think aloud in all the driving sessions. This means that the participant had to tell the meaning of the vibrotactile signals whenever she sensed it. The participant was required to follow the vibrotactile feedback and take driving decisions accordingly. At the end of each driving session the participant stopped the car at a safe parking lot and filled out the usability and workload questionnaires. Afterward, we interviewed the participant. We started the next driving session and followed the same sequence of the steps. So we repeated that procedure for all other driving sessions. At the end of all the driving sessions, we asked the driver to rank all three designs according to their preferences. Each of the driving session was about 2.7 km long. The total time of the whole procedure was about 90 minutes. Figure 4.14 shows a driving track for the experiment.

The participant wore the tactile belt and learnt the three designs. We instructed the participant to drive to the venue (i.e. starting point of the selected route for evaluation) and stop for a while at a free parking lot. We reminded the participant of the first vibrotactile encoding in the sequence, and instructed to drive. We used a Wizard-of-Oz approach in the experiment. The participant was instructed to think aloud in all the driving sessions. This means that the participant had to tell the meaning of the vibrotactile signals whenever she sensed it. The participant was required to follow the vibrotactile feedback and take driving decisions accordingly. At the end of each driving session, the participant stopped the car at a safe parking lot and filled out the usability and workload questionnaires. Afterward, we interviewed the participant. We started the next driving session, and followed the same sequence of the steps. So, we repeated that procedure for all other driving sessions. At the end of all the driving sessions, we asked the driver to rank all the three designs according to their preferences. Each of the driving session was about 2.7 km long. The total time of the whole procedure was about 90 minutes. Figure 4.14 shows a driving track for the experiment.

4.3.3 Results

This section is divided into quantitative and qualitative results. The quantitative results consist of measures like ranking, performance, usability, and workload. The qualitative results consist of the outcome of interview questions, and other observations by the experimenter.

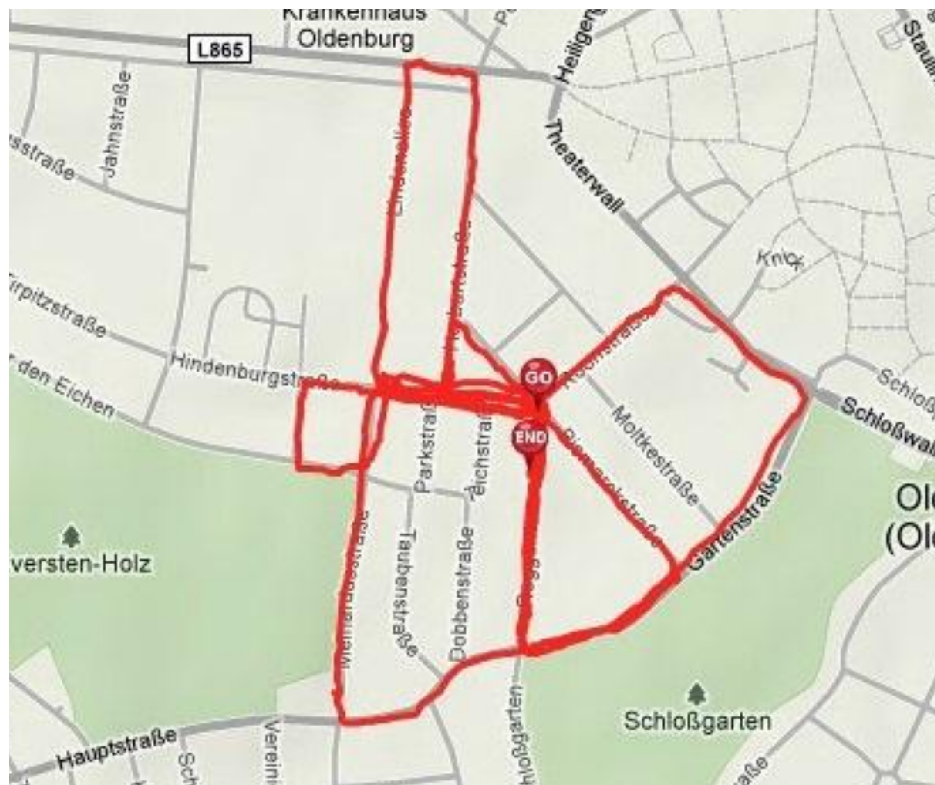

Figure 4.14: Route of evaluation.

Ranking

According to the Friedman test, there is a significant difference in the ranking of the vibrotactile designs, $p < 0.05$. The Wilcoxon test shows that the two vibrators front design was significantly preferred than the one vibrator design, $P < 0.025$. Similarly, the two vibrators front design was significantly preferred to the two vibrators side design, $p < 0.025$. The one vibrator design was ranked significantly better than the two vibrators side design $p < 0.025$. The results in Figure 4.15 show that *two vibrators front* design is most preferred among all. *One vibrator* design stands on the second place. However, *two vibrators side* design was not preferred by the participants.

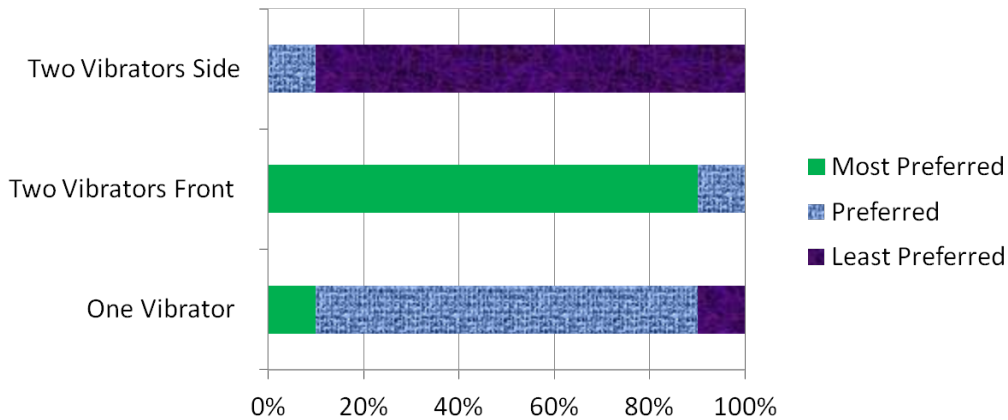

Figure 4.15: The drivers preferences on each vibrotactile encoding for direction presentation.

Performance

We applied repeated measures test on data that we obtained by recording the mistakes of the participants in identifying the vibrotactile signals of direction information. According to the repeated measures ANOVA test, there is a significant difference in the performance of the participants on the vibrotactile direction designs, $p < 0.05$, Chi-square= 11.705. There is a significant difference in the performance of the participants on the *two vibrators front design* and *two vibrators side design* $p < 0.025$. The post-hoc test does not show any significant difference in the performance of the participants on the *one vibrator design* and *two vibrators side design* $p = 0.684$. There is no significant difference in the performance of the participants on the *one vibrator design* and *two vibrators front design* $p = 0.064$.

Figure 4.16 shows that the participants made fewer errors on the *two vibrators front* design in identifying right, front-right, left, and front-left directions as compared to the *one vibrator* and *two vibrators side* designs.

Usability

According to the Friedman test, there is a significant difference in the usability of the *one vibrator*, *two vibrators front*, and *two vibrators side* designs, $p < 0.05$ and Chi-square= 173.868. The Wilcoxon signed ranks test shows a significant difference in the ease of use of the *two vibrators front* design and *one vibrator* design, $p < 0.025$. A significant difference was found in the ease of use of *two*

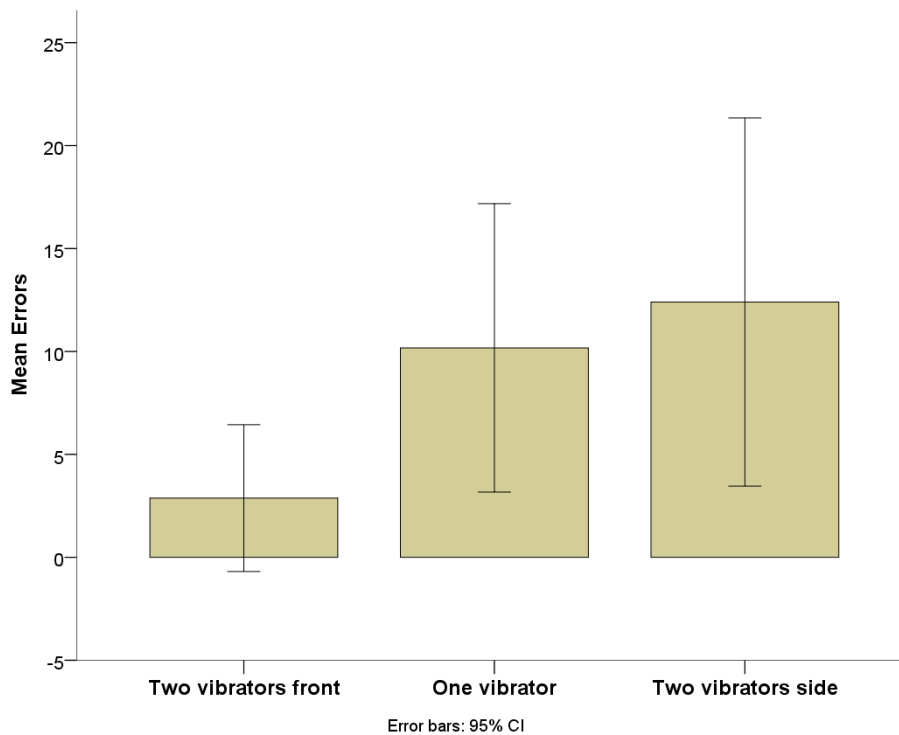

Figure 4.16: The errors made by the participants for identification of direction on the given signal, in three vibrotactile encodings. The participants made least number of errors in the *two vibrators front* encoding for the all directions.

vibrators front design and *two vibrators side* design, $p < 0.025$.

We calculated the usability score according to [Bro96]. Figure 4.19 shows the usability score of the *two vibrators side design* which is comparatively lower than the *one vibrator design* in Figure 4.17 and the *two vibrators front design* in Figure 4.18.

The Figure 4.20 shows, the participants rated the ease of use of the *two vibrators front* encoding better than the other two designs. There is no huge difference in the other usability measures of all the three designs.

Workload

We applied calculations on our data obtained from NASA TLX questionnaire according to the procedure given in [HS88]. On final scores, we applied a Friedman

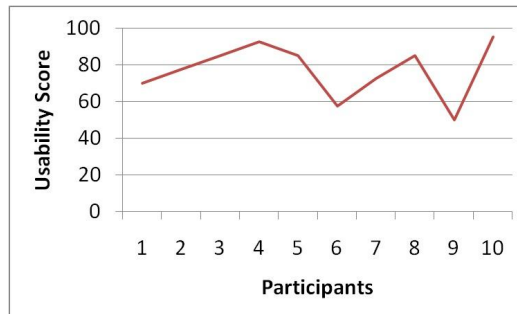

Figure 4.17: Usability score of *one vibrator design*.

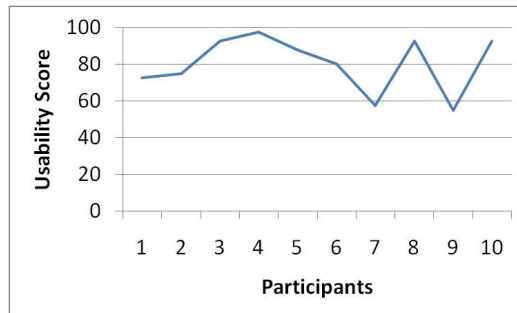

Figure 4.18: Usability score of *two vibrators front design*.

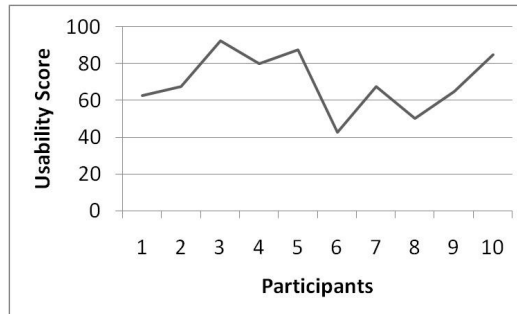

Figure 4.19: Usability score of *two vibrators side design*.

test. According to the Friedman test, there is no significant difference in the workload of the drivers using the *one vibrator*, *two vibrators front*, and *two vibrators side* designs, $p=0.383$ and $\text{Chi-square}=1.92$. Figure 4.21 shows that there is no difference in the workload of the driver on different vibrotactile designs.

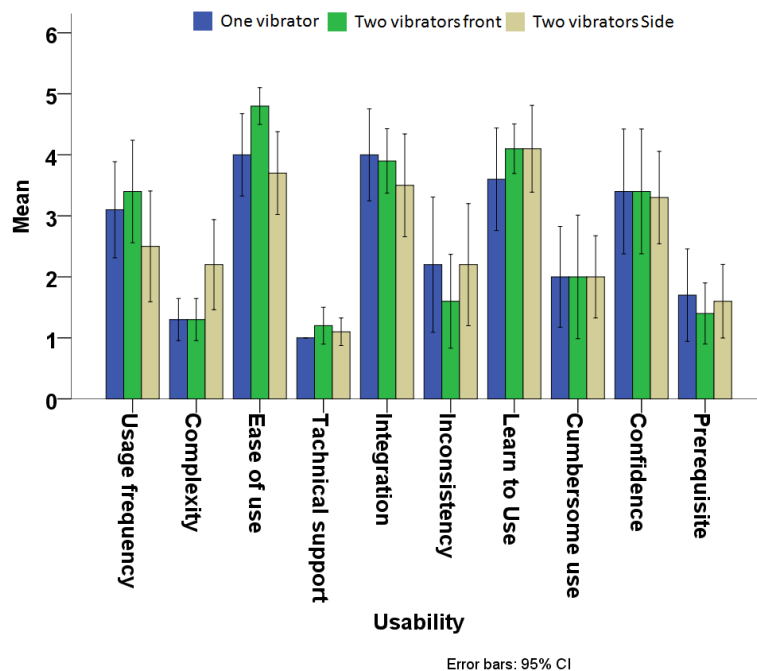

Figure 4.20: Usability measures of the *one vibrator*, *two vibrators front*, and *two vibrators side* encodings, based on SUS questionnaire.

Qualitative Results

We collected qualitative data by interviewing the participants. We asked the questions, such as performance success, signals reorganization, impression on given encoding, distance presentation, distraction with interface, accuracy in identifying directions and distances, need of additional interface, and additional suggestions were asked. We recorded the responses on the sheet of paper.

In *one vibrator* configuration, few participants make comments, such as "I am not as sure that I performed successfully as compared to *two vibrators front design*." 2 participants were pretty much sure and 3 were not sure about their success in using this system. On *two vibrators front design* encoding, six participants were very much confident on using this system. Two of them were on just sure and two were unsure about their success in using this system. In *two vibrators side* encoding, 3 participants were just sure about their success, and 7 of them were unsure about using this system.

In all the three configurations, most of the participants were unable to recog-

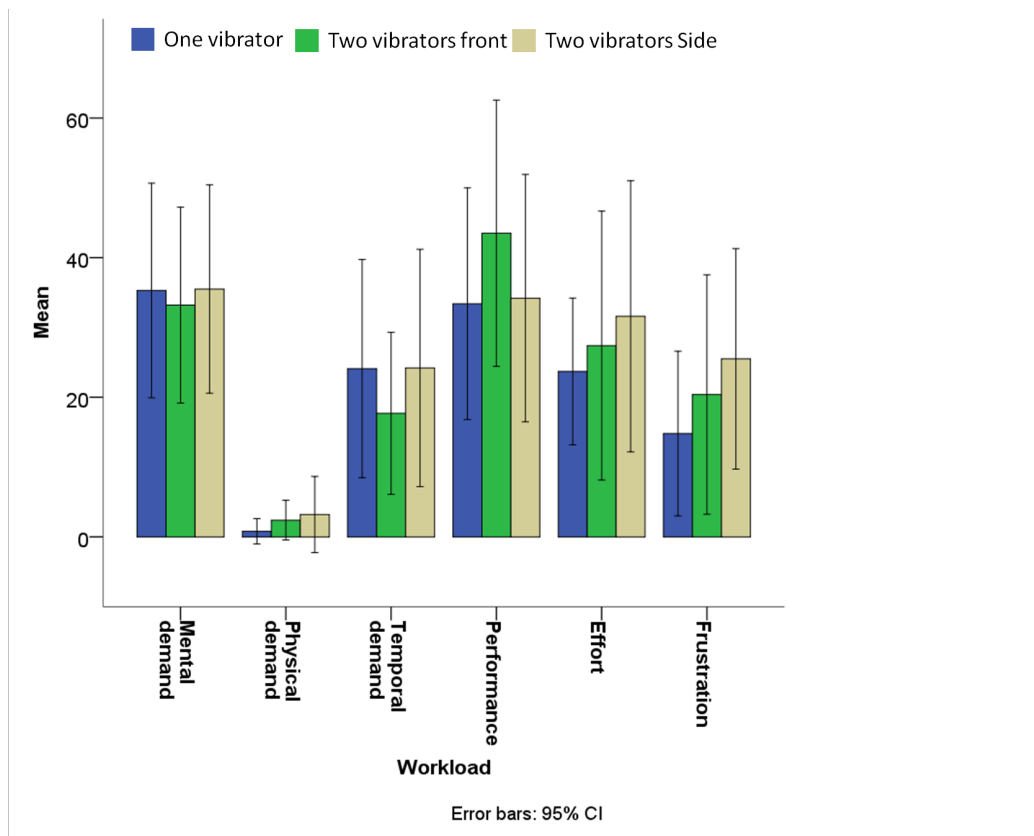

Figure 4.21: Workload comparison of the *one vibrator*, *two vibrators front*, and *two vibrators side* encodings, based on NASA TLX questionnaire.

nize all the signals. In *one vibrator design*, 6 participants were unable to recognize all the signals and 4 were able to recognize the signals. On *two vibrators front design*, 7 participants were able to recognize all the signals. In *two vibrators side design*, 8 participants were able to recognize all the signals.

The participants responded on the question of their overall impression on the 3 design encodings. In *one vibrator* encoding, the participant told "sometimes it is difficult to differentiate front-right and front-left direction to right and left directions respectively." While answering the overall impression question, the participant said that "*one vibrator* and *two vibrators side* design are complicated but people can get used to it." "*Two vibrators front* design is not complicated but sometimes irritating." "*one vibrator* design is better than *two vibrators side design* and easier to use", "I think *two vibrators front* design is the best, it is easier

to feel if vibration occurs more in front", and " *two vibrator* side design is difficult to distinguish." "*One vibrator* encoding needs a learning phase to get used to this design", "*two vibrators front* encoding was better than others and signals sensed stronger and longer", "other two configurations are better, and *two vibrators side* encoding stand on the least place."

In all the three vibrotactile direction encodings, the participants think that distance presentation was helpful in making on-time orientation decisions. Similarly, the participants thought that the presentation of navigation information with this user interface was not distracting for them.

In *two vibrators front* encoding, participants thought that they recognized directions and distances very accurately in contrast of *two vibrators side* encoding. In *one vibrator* encoding 3 participants were confident that they recognized directions and distances very accurately, 6 voted for accuracy and 1 was not confident for accuracy. In *two vibrators front* encoding, 6 participants were very confident for accuracy, and 4 were only confident for accuracy of direction and distance information. In *two vibrators side* encoding, 1 participant was very confident for identifying direction and distance very accurately, 3 were only confident, and 6 were not confident at all.

Most of the participants asked for visual aid with all the three vibrotactile configurations. One participant required either visual or auditory support, 1 required both of them, 3 participants needed visual, and 1 participant asked for audio support, and 3 of them requisite none of them in *one vibrator design*. In *two vibrators front* encoding, 4 participants asked for the visual support and 1 participant requested auditory support, and 2 participants needed either one of them.

In *two vibrators side* encoding, 5 participants asked for rather visual or auditory support, 1 participant required visual and auditory support and 3 participants did not request for anyone. The vibrotactile direction configurations were easy to learn for the participants. Mostly, the user interface was easy to learn. 1 participant told that "I did not understand *one vibrator* encoding quite well, it was difficult to receive that information and talk aloud." 3 participants said that it was difficult for them to learn *two vibrators side* encoding.

4.3.4 Discussion

The tactile interface is appreciated by the participants as an alternative way of displaying the direction information in a car navigation system. The tactile belt successfully presented the left, front-left, right, and front-right directions to the drivers. The *two vibrators front design* was the most preferred interface for pre-

senting the direction. But the overall qualitative and quantitative results do not reveal much difference between the *two vibrators front design* and *one vibrator design* for the presentation of direction information on urban roads. In the following, we discuss the hypotheses according to our results:

H1: The results showed a significant difference in the performance of the participants on *one vibrator*, *two vibrators side*, and *two vibrators front* designs for the presentation of directions. The participants made significantly more errors on *two vibrators side design* as compared to *two vibrators front design*. The graph of the performance showed that the error rate of the participants in identifying the vibrotactile signals for all the four directions was lower on the *two vibrators front design* as compared to the other two designs. The qualitative observations also demonstrated that having vibrations for front-left or front-right directions more towards front made the vibration signals more distinguishable to the left or right directions. Because the vibration of left or right sides feels more towards the corner than to the front for front-left and front-right sides. However, overall results of the performance do not conclude between *one vibrator design* and *two vibrators side design* for direction presentation. Our results support the finding of our pilot study in [AB10]. The *two vibrators side design* is, therefore, inappropriate for the direction presentation with the tactile belt according to the statistical results, and many errors made by the participants. This supports the results of the previous pilot study. Furthermore, the results favor the *two vibrators front design* for the presentation of direction with least amount of performance errors.

H2: The results showed a significant difference in the ease of use of the *two vibrators front design* as compared to the other two designs. The usability graph does not indicate much difference in the other factors of usability of the *two vibrators front design* and the *one vibrator design*. The participants ranked the *two vibrators front design* significantly better than the other two designs. The reason of the ranking results could be that for the *two vibrators front design*, the signals were sensed more towards the front and could be better differentiated than the other two designs. In contrast, the *two vibrators side design* was felt more on left or right. The qualitative results are more in the favor of the *two vibrators front design* for direction presentation. Since only one factor of usability, i.e., ease of use, is significantly better in the *two vibrators front design* as compared to the other two designs, we partially qualify the *two vibrators front design* as usable vibrotactile feedback for direction presentation.

H3: The results did not show any significant difference on the workload of the drivers in all the three vibrotactile designs. The workload graph indicated that the participant rated more workload on the *two vibrators side design* as com-

pared to the other two vibrotactile designs. However, with given results we cannot conclude any winner vibrotactile design for the direction presentation which imposes less workload on a driver. The qualitative results favor the *two vibrators front design* more than the other designs. The results do not indicate a significant difference among all the three designs for direction presentation.

This study was carried out on the urban streets; the results might be applicable on motorways with some variations. The evaluation was carried out with the help of a prototype system that controlled by the experimenter. Therefore, chances of buggy feedback and human errors cannot be neglected.

The quantitative results for performance and usability partially support the *two vibrators front design* for the presenting directions in a car navigation system. But statistical measures did not reveal any significant difference between the *two vibrators front design* and *one vibrator design*. So, we cannot fully eliminate the one vibrator design for presenting the directions. On the basis of quantitative difference and qualitative data, we can conclude that the *two vibrators front design* is comparatively best suited for the direction presentation among all the designs. The findings of our study are overcoming the limitations of the pilot study and helpful in concluding a suitable vibrotactile design for the direction presentation. Our findings for the route guidance of drivers supports the designs of the tactile belt by Heuten et al. [HHPB08] for the route guidance of blind and pedestrian users. In automobiles, the directions are limited to right, front-right, left, and front-left while a pedestrian has more choices of orientation in the environment that needs more accuracy. The results might be helpful for the automotive industry to bring the tactile interface into the car navigation systems.

4.3.5 Conclusion

The tactile display can successfully be utilized to present the direction information in the car navigation systems. The findings of the study support the other studies conducted in [HR10, KMH⁺09, VEK09]. First, we conducted a pilot study to compare 4 different vibrotactile direction encodings *block design*, *one vibrator design*, *two vibrators front design*, and *two vibrators side design*. We found that the *one vibrator design* and *two vibrators front design* were more preferred to present the direction information. Secondly, we conducted an experiment with 10 participants to compare *one vibrator design*, *two vibrators front design*, and *two vibrators side design*. We evaluate these encodings on performance, usability, and workload.

The drivers performed the best on *two vibrators front design* for the direction

information. So, the *two vibrators front* design might be considered better for displaying direction information to a driver. The drivers liked the idea of presenting the navigation information with the tactile interface. They preferred to have visual support with the tactile interface. The tactile display was not distracting the drivers from any other task in the cars. Learning this interface was quite easy as well, although the drivers were not regular users of the tactile display.

4.4 Distance Presentation with a Tactile Display

There are many potential ways to use vibration for encoding distance similar to the direction presentation described in Section 4.3. According to [BB04, Erp02], the tactile parameters that can be modified to encode information in general are: frequency, amplitude, waveform, duration, rhythm, and body location. The frequency is the number of cycles per second [Man05]. Vibration stimuli will be detected, when the amplitude exceeds a threshold which is dependent on several parameters including frequency [Erp02]. The parameters of frequency and amplitude are not well suited to encode information [VSE04b]. The change in voltages results is a change in frequency and amplitude simultaneously [GH93]. The change is almost linear given in Precision Microdrive². So, we can treat the frequency and amplitude as one parameter of intensity by following the approach in [PKB10]. Furthermore, we cannot modify the waveform of the signal as its manipulation would require specific hardware [Erp02]. Further parameters for encoding distances are rhythm and duration. The rhythm is created by grouping a number of pulses in a temporal pattern. Varying the duration of the vibrotactile signal means to vary the length of a single pulse.

We can design different vibration patterns by modifying the intensity, rhythm, duration, and the body location. In this study, the body location of vibrotactile cues is already used for presenting direction as the vibrotactile waist belt uses the left and right vibrators to encode the direction of the upcoming turn. Thus, it cannot be used further for distance encoding. In summary, encoding distance by vibration can be conducted by altering the parameters intensity, rhythm, and duration. These parameters can be altered individually or in combination. Following options are available for the adjustment: intensity only, rhythm only, duration of the signal, intensity *and* rhythm, intensity *and* duration, and rhythm *and* duration. In order to validate, whether all of these options were easy to perceive, to

²https://secure.precisionmicrodrives.com/product_info.php?products_id=92

distinguish and to interpret by the driver, we investigated them in the first pilot study.

4.4.1 Pilot Study

The overall aim of the pilot study was to explore the usefulness of the different ways of encoding the distance information with vibrotactile signals. We conducted the pilot study to select the possible tactile parameters for encoding the distance information in the real driving scenarios. The results of the study helped us in the design of vibrotactile distance encodings for a further comparative evaluation.

In addition, the pilot study was conducted to provide the proof-of-concept of displaying distance information with only tactile feedback on the real road.

Participants, Apparatus, and Procedure

One female participated in the pilot study. She had 25 years of driving experience. The vibrotactile signals are used to present distance information to the participant. The participant tested rhythm *and* duration based design, rhythm *and* intensity based design, duration *and* intensity based design, intensity only design, rhythm only design, and duration only design. The parameters of duration, intensity, and rhythm are explained in Section 2.4 in detail. We adapted the approach of thinking aloud to collect the participant's comments and observations. We made videos for data collection. We measured the vibrotactile signal perception and performance on distance categories.

The distance signals were controlled by an experimenter who was sitting on the backseat of the car. The participant was trained on all the designs before going to the driving sessions. The participant drove in multiple sessions. In each design, the participant drove at least two times. The participant was speaking whatever she thought about the vibrotactile signal perception and categories of distance. The videos were analyzed post-studies to collect the results.

Results and Discussions

We found that the rhythm based distance encoding, intensity *and* rhythm based distance encoding, and duration *and* rhythm based distance encoding are acceptable according to the participant's comments. The respective category of distance

relative to the quantitative range of distance is given in Table 4.2. In the following, we discuss our observations and the driver's comments of the pilot study in detail:

Categories of distance: In distance encoding, the signal of *turn-now* is required to be comparatively intense and easy to identify to make sure that the driver has to take turn at that moment. According to observations, the vibration signal for *turn-now* will be few meters (i.e. 10m) before the next crossing while driving on the street.

Vibration patterns in automobiles: The driver commented that *"I get strong sensations with less number of pulses, and while increasing the number of pulses feeling-wise, it is less intense"*. The driver gets smooth sensations with a higher number of pulses in a small time interval (e.g. minimum six pulses per second). The vibration pattern sensed intense and distinct if less pulses took place in a longer time interval (e.g. 2 pulses per second). The participant commented that *"The vibration is not easy to feel and I am undecided between different levels of intensity"* for only intensity-based distance encoding. We observed that the participant annoyed by the intensity only vibrotactile signal. Furthermore, it was difficult for the participant to understand the distance information. Consequently, it is difficult to select among only rhythm, intensity *and* rhythm, and duration *and* rhythm based vibrotactile distance encoding. We concluded that all designs in combination with rhythm are successful for vibrotactile distance encoding.

We observed that the participant was annoyed by the intensity only vibrotactile signal. Furthermore, it was difficult for the participant to understand the distance information. We discovered that rhythm was an important parameter for vibrotactile information encoding in the car navigation system. We discovered that it was possible to get appropriate rhythm by changing a number of pulses while keeping the constant level of the intensity. Consequently, it is difficult to select among only rhythm, intensity *and* rhythm, and duration *and* rhythm based vibrotactile distance encoding. We concluded that all designs in combination with rhythm were successful for vibrotactile distance encoding.

Although we conducted this study with only one participant, the observations and the driver's comments helped us a lot to improve vibrotactile distance encodings for further comparative experiment. The pilot study provided a proof-of-concept that the tactile feedback was successful to present the distance and direction information to the driver on the real road without the support of visual and auditory modalities. In the following duration, intensity, and rhythm are used to encode distance. The driver recognizes the information in the form of countable pulses, the distinct rhythm patterns.

Category of Distance	Distance (meters)
Very Far	200-150
Far	100-80
Near	50-30
Turn Now	10

Table 4.2: The quantitative categories of four distances.

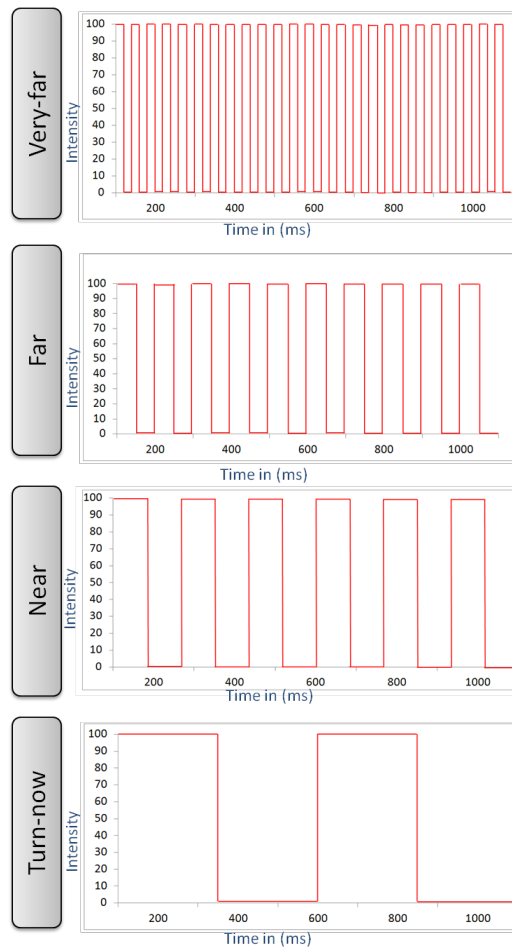

Figure 4.22: Rhythm based distance encoding consists of different patterns of pulses for different categories of distance.

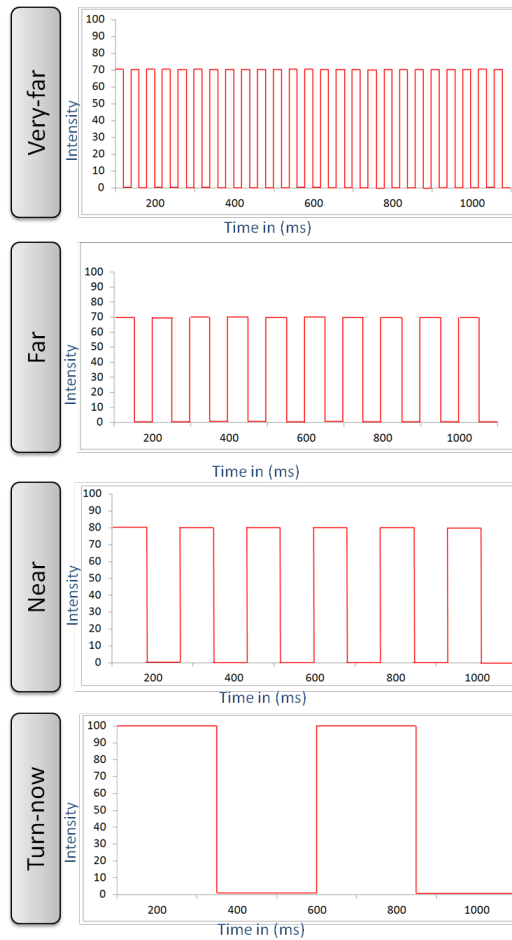

Figure 4.23: Rhythm & intensity based distance encoding consists of different patterns of pulses with different intensity levels.

4.4.2 Distance encoding in vibrotactile cues

In the pilot study, we got very useful observations regarding the tactile parameters for presenting distance information in the cars. We tested the vibrotactile encodings for the presentation of distance information in the cars, but discarded some of them due to their negative aspects. The driver was annoyed by intensity only encoding for presenting the distance information. It is hard for a driver to distinguish between the lengths of vibrotactile pulse based on duration only encoding. It is possible that the driver might not concentrate on some initial milliseconds of

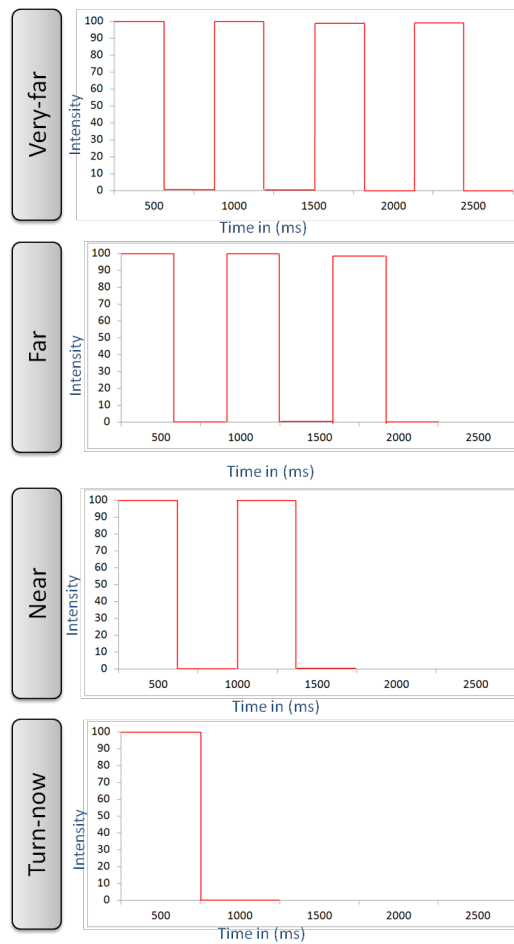

Figure 4.24: Rhythm & duration based distance encoding consists of different patterns of pulses for different categories of distance.

a vibrotactile signals. Similar to intensity only and duration only vibrotactile designs, the driver was annoyed with intensity *and* duration based encoding. Since, the presentation of vibrotactile signal was not different at all between the intensity only design and duration *and* intensity based design.

We are able to select three promising vibrotactile distance encodings based upon our pilot study and observations. In these designs, the three combinations of the tactile parameters propagate the most meaningful vibrotactile signals for distance presentations in a car are: rhythm only, duration *and* rhythm, and intensity *and* rhythm. The relative distance of the car from incoming crossing is

divided into four categories: *very-far*, *far*, *near*, and *turn-now*. In the three designs, we encoded the categories of distances (see Table 4.2). These categories are distinguishable by the vibrotactile signals of rhythm based design, duration *and* rhythm based design, and intensity *and* rhythm based design. The first design utilized the parameter of rhythm, the second one utilized the parameters of rhythm *and* intensity, and the third design made use of rhythm *and* duration. In the first two designs, the driver perceives a very smooth vibration at the distance of *very-far* and a very intense vibration at the distance of *turn-now*. The third design – rhythm *and* duration encoding – conveys countable pulses to the driver. The three designs are explained with the help of graphical representation (see Figures 4.22, 4.23, 4.24), where the vertical axis presents the level of intensity and the horizontal axis presents time in milliseconds (ms).

The four categories of distance are presented from the top to the bottom in the diagrams. The technical characteristics of the three designs are outlined in the following:

Rhythm based distance encoding: The graphical visualization of only rhythm based distance encoding is shown in Figure 4.22. The encoding of a distance signal is presented with its intensity and length. The event is composed of pulses per second. A pulse is composed of its activation and deactivation states. The intensity is same for all the four events. If we observe from the top to the bottom the design consists of 25 pulses for the *very-far*. The *far*, *near* and *turn-now* consist of 10 pulses, 6 pulses, and 2 pulses respectively.

Rhythm and intensity based distance encoding: The graphical visualization of the intensity and rhythm based distance encoding is presented in Figure 4.23. The distance is encoded in pulses per second with variable intensity. A pulse is composed of its activation and sleeping states. If we look from top to bottom in the diagram, an event of *very-far* is composed of 25 pulses with 70% of intensity level. On the second place, the event of *far* is composed of 10 pulses with 70% of intensity. On the third place, the event of *near* is composed of 6 pulses with 80% of intensity, and in the bottom the *turn-now* event consists of 2 pulses with maximum intensity.

Rhythm and duration based distance encoding: The graphical visualization of the duration and rhythm based distance encoding is presented in Figure 4.24. In this design the pulses are more intense and less in a number. The distance is

presented with a number of pulses in the given time along with its intensity level. A pulse is shown with its activation and deactivation states. The first event is composed of 4 pulses of the length of 2.5 seconds. The inter-stimulus interval between the pulses is 313 ms. The second event consists of 3 pulses of the length of 2 seconds. The inter-stimulus interval between the pulses is 333ms. The third event is encoded as 2 pulses of length of 1.5 seconds. The inter-stimulus interval between the pulses is 375ms. The fourth event is encoded as one pulse in a second with 500 ms inter-stimulus interval. Considering the factors, such as speed of a car in a city, the driver will get enough time to perceive and interpret the vibrotactile signals and make driving decisions e.g. if a car is running with speed of 50 km/h, then a driver will get 4.7 seconds between very-far and far signal.

Direction presentation with distance encoding: The direction and distance information is required to present on urban road intersections to convey the navigational instructions to a driver. We evaluated all of the vibrotactile designs on the real urban roads. In this case, the drivers have to cross different road intersections. A driver cannot decide to turn a car toward left or right from the crossing without knowing the direction in advance. We, therefore, presented all the distances in combination with the previously evaluated vibrotactile designs of directions (see Section 4.3). The vibrotactile combination of direction and distance is presented with the help of scenario in Figure 4.4. The car has to turn on the left lane. Each distance *very-far*, *far*, *near*, and *turn-now* is presented on the left hand side of the tactile belt to display the left direction. The direction is presented with the above selected rhythm based encoding, intensity *and* rhythm based encoding, and duration *and* rhythm based encoding of distance presentation.

The above designs account for the fact that the driver might have missed the start of the sequence. On the basis of the pilot study, we proposed the three different methods of distance encoding based on: only rhythm, intensity *and* rhythm, and duration *and* rhythm. In the following section, we present the design of the experiment in which we compared the methods of distance encoding.

4.4.3 Evaluation

We analyzed rhythm, intensity and duration to encode vibrotactile messages to present distance information in the car. We conducted a pilot study and exposed the three appropriate vibrotactile designs to present distance information i.e. (i) only rhythm, (ii) intensity *and* rhythm, and (iii) duration *and* rhythm. It is not

possible to integrate all the three vibrotactile methods of presenting distance information in a single car navigation system. So, we are required to compare all the three vibrotactile designs for presenting distance information in an evaluation. We conducted an evaluation to find a suitable vibrotactile encoding for presenting distance information in the car. In order to present directions of the streets, the different vibrotactile encodings for distance presentations were coupled with the *two vibrators front design* that was explored in Section 4.3. The goal of the evaluation is to compare the different approaches to encode distance information with vibrotactile signals to discover one appropriate vibrotactile encoding. We aim to investigate the most simple vibrotactile distance encoding for the driver that leads to successful task completion. The comparative evaluation investigates the specified questions:

Q1: Will the participants perceive turn-by-turn distance information without the support of visual and auditory modalities in the car?

Q2: Which one of the encodings – rhythm, rhythm *and* intensity, rhythm *and* duration – is the most usable encoding?

Q3: Which distance encoding helps the driver to make the least number of information perception / interpretation errors?

Q4: What are the common errors that the participants commit to interpret distance information by using the tactile display?

Experiment Design

Our experiment consists of one independent variable. The vibrotactile signal presents the direction and distance information to the participants. We compared the three vibrotactile distance encodings while driving in the real urban environments. The approach of the experiment was within subject, with 3 different routes and 3 different vibrotactile encodings of the distance. In the within subject approach, the different experimental conditions are the three vibrotactile distance encodings, and the same participants have been used in all the conditions.

Dependent Measures

In an experiment, the outcome variable is called dependent variable, not manipulated by an experimenter [FH03]. A dependent variable depends on other variables in an experiment. Our experiment might contain many dependent variables. Considering the questions for the evaluation of Q1 to Q4, we selected the measures of

usability of the designs, information perception errors, and cognitive workload as dependent measures.

Usability of the designs: We measure usability in the terms of information perception, learnability, length of vibrotactile signal, ease of use, and user's judgment rating on the design. We asked the participants to rate the design's usability on a questionnaire after completing each route.

Information perception errors: Information perception errors are the number of errors made by the participant in identifying the category of distance. We measure a number of participants' wrong responses on the categories of distance for quantifying how many errors they made in perceiving the distance information. Furthermore, we analyzed how they interpreted the categories of distance.

Distraction: We analyzed the drivers' responses and videos to measure the distraction.

Participants

We evaluated a total of 13 participants, 1 female and 12 male in our experiment. The participants were between 20-40 years old. All participants voluntarily participated in the experiment. Each participant completed all the three sessions of the experiment. The participants have in the average 12 years of driving experience. We conducted (3x13) driving sessions with all the participants in the whole study. We evaluated 3 participants after the sunset and 10 in the daylight. All participants completed assigned tasks easily in both conditions.

Apparatus

We used a fully automatic Volkswagen Touran car in all sessions. The tactile belt is used to provide navigational aid in all the three driving sessions (see Figure 4.25). The tactile belt (see Section 4) is integrated to be worn around the waist of the driver.

We have used the questionnaires, video recording, and screen captures for the collection of data.

Questionnaire

The questionnaire consists of questions regarding the dependent measures like the information perception, and usability of the designs. The users' responses are



Figure 4.25: The experiment setup.

gathered on a 10 point scale. The scale is numbered from 1 to 10 and presents negative to positive.

Interviews

In the end of the driving sessions, the participants were interviewed. They were asked about their impression regarding the vibrotactile distance encodings, all the driving sessions, tactile display preference over other displays, distraction, and any further comments.

Screen Captures and Videos

Video recordings are used for the data collection. Considering ethics, we have taken participants' signatures for their willingness to record their videos. The open source software CamStudio is used for capturing the laptop screen of the experimenter and the voice of the participant. The participants were asked to announce the category of distance every time when they feel vibration. Different categories of the distance pointed by experimenter are captured from the laptop screen. Afterward, the participant's oral response on the category of distance is compared with screen captures. A custom built application is used to analyze data from the videos and CamStudio. In the custom built application, the keys of key-

board contained meaningful information related to correct and incorrect responses of the driver e.g. the participant's response on *very-far* as *far* can be considered as meaningful information. On sensation of the vibration signal, the driver guesses the category of distance by thinking aloud. Later, an analyzer watched the screen capturing segment with video. The analyzer presses the keys according to the response of the participant about the information signal. The information produced in the procedure is saved in a text file. The videos are observed two times by the analyzer.

Procedure

The distance signals are controlled by the experimenter. The experimenter is seated next to the driver. During the driving session, the four categories of distances are presented to the next crossing. We presented the categories of distance according to the length between two crossings e.g. all the four categories of distance are displayed to the participant, if the length (in meters) is in the range of *very-far* distance (see Table 4.2). Furthermore, we displayed the 3 categories of distances if the length is in the range of the *far* distance and so on. We have created random sequences of the designs to balance any learning effect.

Before going to the venue, we explained the whole process of the experiment and trained each participant on all the designs. Each participant was trained on the distance designs in five minutes sessions before leaving for the real driving. The training was repeated before the beginning of every session.

The participants were relying on the tactile belt to drive from the origin to the destination. Turn-by-turn direction is displayed by tactile feedback. Each participant drives according to a random sequence of designs in the experiment. The participant is again trained on the first design in the sequence until he will be able to confidently recognize the signals presenting the categories of distance. In addition, the graphical presentation of the different designs – as shown in Figures 4.22, 4.23, 4.24 – has been provided. After completing the first route, the driver is asked to park the car on a safe place and to fill out the questionnaires. Then the driver is trained on the second design in the sequence until he will be able to confidently recognize the signals presenting the categories of distance, and so on.

Figure 4.26 presents the three different routes the participants had to drive. The lengths of route 1, route 2, and route 3 are 1.3 km, 1.2 km, and 1.4 km respectively. In the whole experiment, the participants drive on every route at a minimum of 4 times for each design. The order of the designs was changed amongst the participants. We, however, kept the same order of the driving routes.

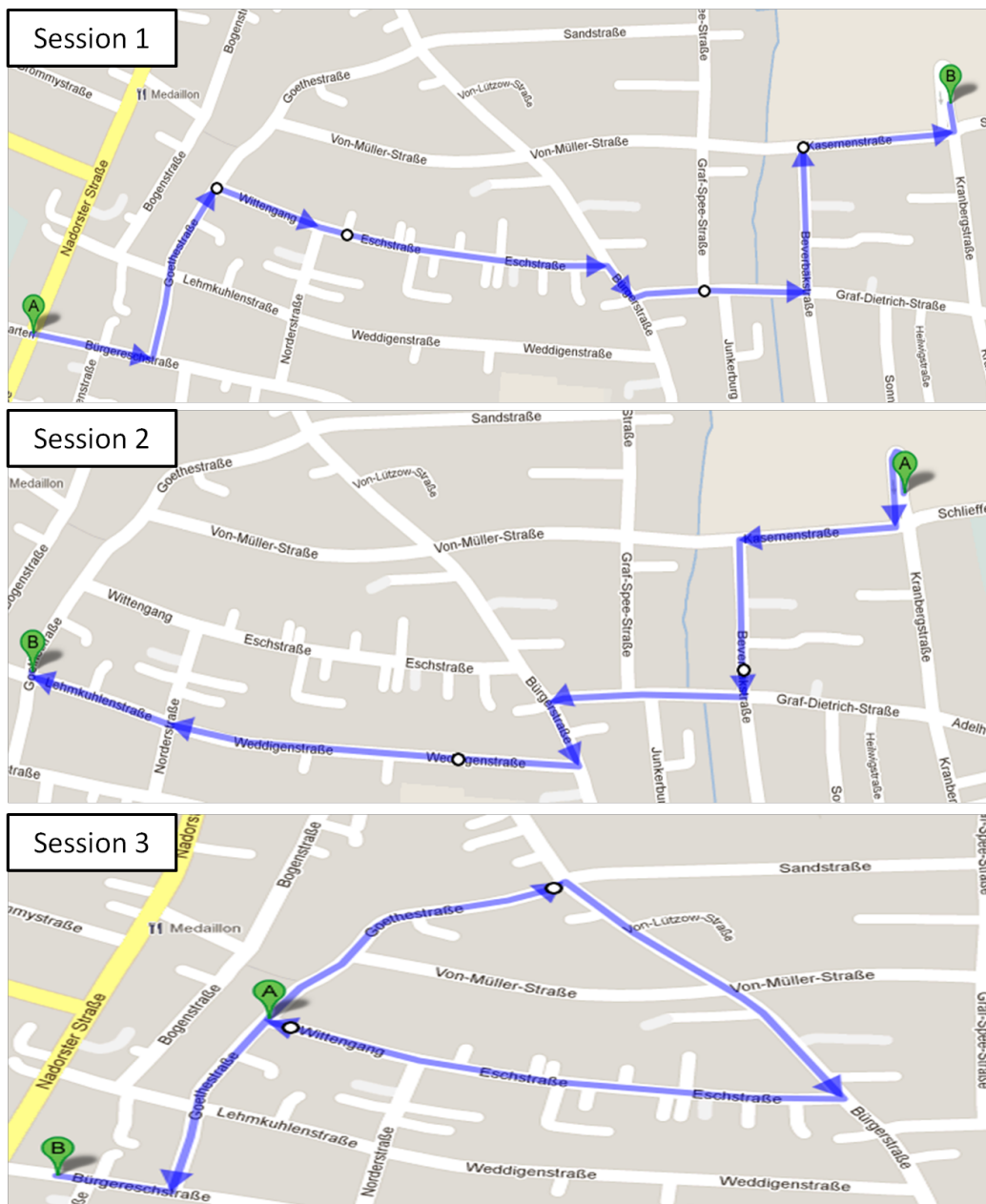

Figure 4.26: Three routes are used for driving in the experiment.

4.4.4 Results

All the participants were able to complete all the driving sessions. In the following, the results are divided into quantitative and qualitative results. The quan-

titative results provide the dependent measures like usability of the vibrotactile distance encodings, and information perception errors. We applied statistical test to analyze the quantitative results. Similarly, we collected additional observations and the participants' comments regarding the vibrotactile distance encodings in the qualitative measures.

In the following, we discuss the quantitative results of our evaluation.

Quantitative Results

In the following, we present the quantitative results of our evaluation, structured with respect to the dependent measures (see Section 4.4.3). We applied a non-parametric Friedman's ANOVA test on data collected from the questionnaire to measure usability of the vibrotactile distance encodings. Furthermore, to know the difference between individual conditions we applied Wilcoxon tests on each pair of conditions, we applied a simple descriptive statistics on the quantitative data collected from the videos and screen captures to measure information perception error. The results are presented with the help of boxplot and simple bar charts.

Usability of the Distance Encodings

The participants ranked the designs as *most preferred*, *preferred*, and *least preferred*. Figure 4.27 presents the participants' ratings for the three vibrotactile designs. The rhythm *and* duration based distance encoding is the most preferred design according to the statistics. The rhythm *and* intensity based distance encoding is rated as *preferred*. The rhythm based distance encoding is rated as the *least preferred* design by the participants.

Figure 4.28 presents the participants' response on the learnability of the designs. The Friedman's test shows that learnability of vibrotactile distance designs are significantly different (Chi-Square=9.19, $p < .05$). Further, the Wilcoxon test depicts that the learnability score of duration *and* rhythm based distance encoding is significantly higher than intensity *and* rhythm based distance encoding, $p < .025$. Similarly, learnability score of the duration *and* rhythm based distance encoding is significantly higher than the rhythm based distance encoding, $p < .025$.

In Figure 4.29, the boxplot presents the participants' responses about information perception. The Friedman's test shows that the participants perceive information significantly different in all designs (Chi-Square=10.286, $p < .05$). Further, the Wilcoxon test shows that the information perception in duration *and* rhythm based distance encoding ranked significantly positive than the intensity

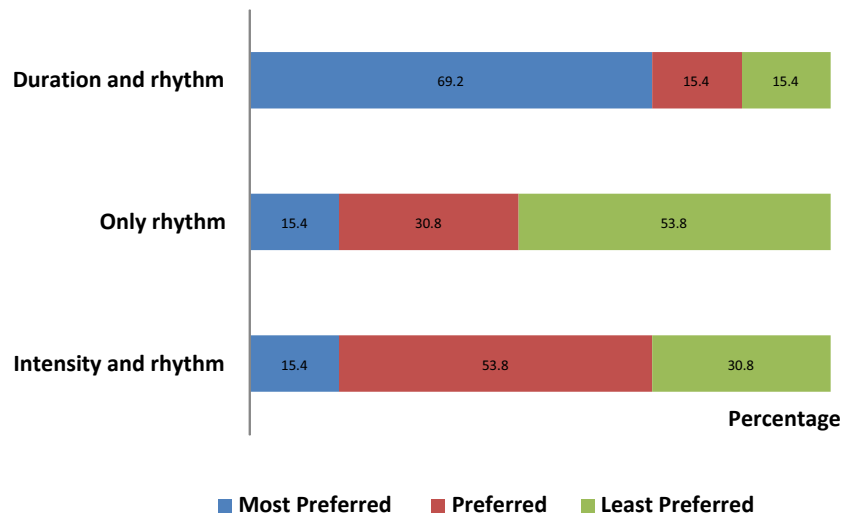

Figure 4.27: Preference ratings for the different tactile designs.

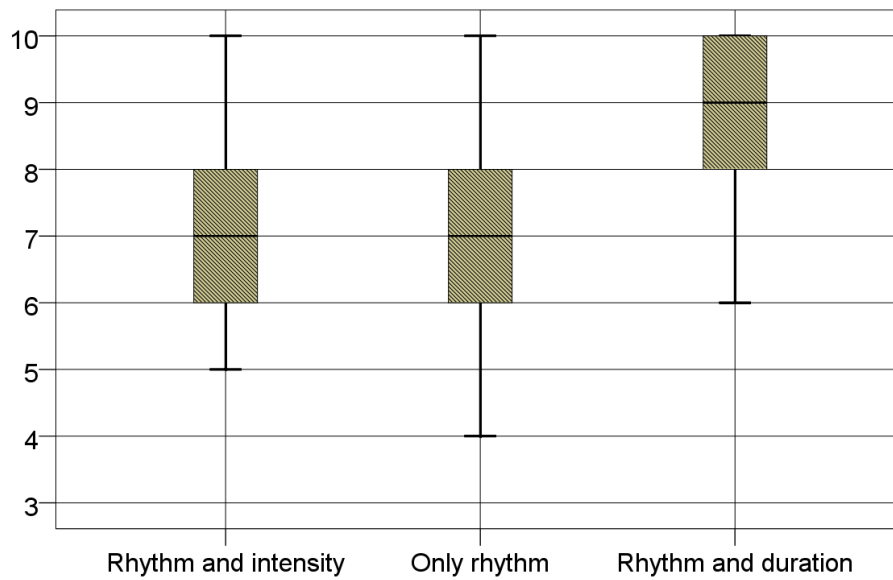

Figure 4.28: Learnability results.

and rhythm based distance encoding, $p < .025$. There is no difference in information perception of duration *and* rhythm based distance encoding, and rhythm based distance encoding, $p = .044$.

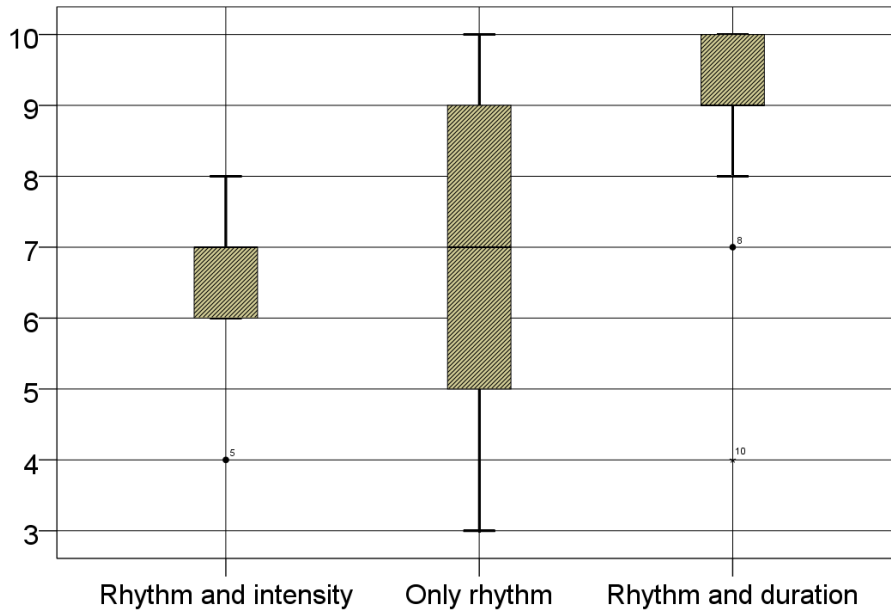

Figure 4.29: Ease of information perception results.

Figure 4.30 presents the participants' responses on the length of vibrotactile signal. The participants' acceptance of the length of vibrotactile signals in the three designs is significantly different (Chi-Square=6.884, $p < .05$). The Wilcoxon test shows no significant difference exists in participants' preferences on the length of the vibrotactile signal between the duration *and* rhythm based distance encoding, and the intensity *and* rhythm based distance encoding, $p = .034$. Similarly, no significant difference exists in participants' preferences on the length of the vibrotactile signal between duration *and* intensity based distance encoding and rhythm based distance encoding, $p = .067$.

The Friedman's test does not reveal any significant difference in the rating of the design judgment in all three vibrotactile distance encodings, (Chi-Square=4.478, $p = .107$).

According to the Friedman's test, there is no significant difference in the ease of use of the three designs, (Chi-Square=2.600, $p = .273$).

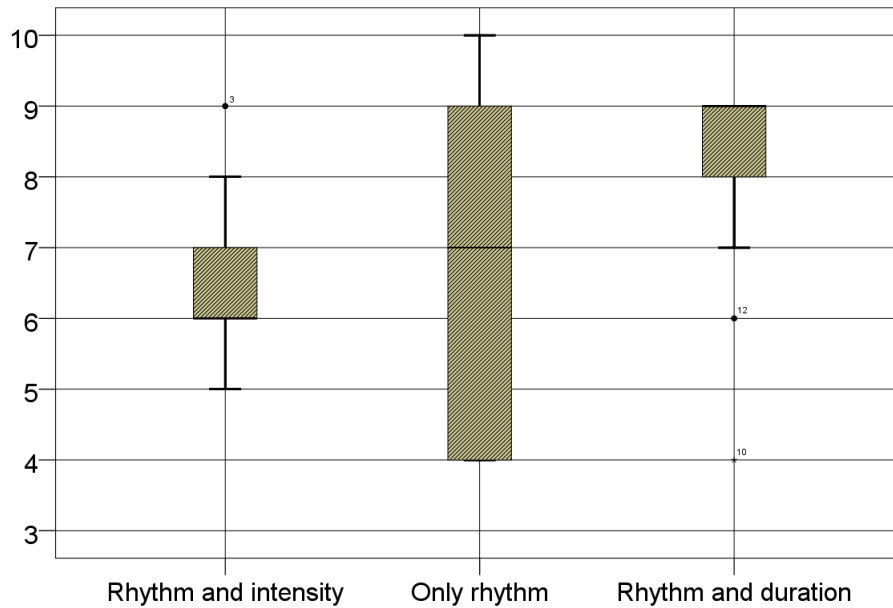

Figure 4.30: Time lengths of signals results.

Information Perception Errors

The three designs have been compared by the number of errors made by the drivers in recognizing the category of distance. The percentages in Figure 4.31 show that the participants made the least number of mistakes in recognizing all categories of distance in the duration *and* rhythm based distance encoding. In the rhythm based distance encoding, the drivers made most of the errors in perceiving a *very-far* distance, 35.7%. We observed the maximum error rate in recognizing *far*, *near*, and *turn-now* distances in the intensity *and* rhythm based distance encoding, 25.5%, 26%, and 7.2% respectively.

Figure 4.32 shows that regarding the rhythm based distance encoding the drivers made most of mistakes in recognizing *very-far* as *far*, 33.3%. Furthermore, the drivers made equal amount of mistakes in recognizing *far* as *very-far* and *near*, 7.7%. The participants made mistakes in recognizing *near* as *far*, 17.5%.

Figure 4.33 illustrates that most of the times, the drivers made mistake in guessing the *very-far* distance as *far*, 12.8% in the rhythm *and* intensity based distance encoding. The drivers made higher number of errors in recognizing *near* as *far*, 26%.

A few mistakes of the participants were observed in rhythm *and* duration based distance encoding according to Figure 4.34.

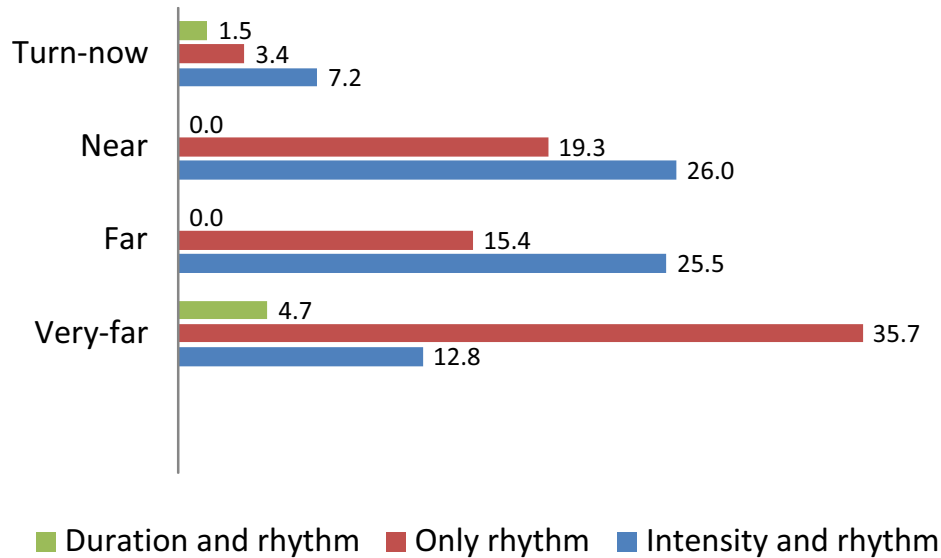

Figure 4.31: Error rates in recognizing distance categories in relation to all three designs.

The comments and responses have been collected with the help of video recordings. In general, most of the participants liked the vibrotactile display in the car navigation system. The participants stated that the tactile vibration was sensed more effectively in sitting position inside the car. In the following, we structured qualitative findings by the aspects of engagement with the environment, visual and auditory modalities, driver distraction and categories of distance.

Workload

The NASA Task Load Index is used to measure the cognitive workload of the drivers of the car. There is no significant difference observed in the workload of the drivers for the three design solutions. In Figure 4.35, means of the participants' rating for their workload is presented with the bar chart. Over all, the means of the drivers' rating show a lower cognitive workload for the three designs. The drivers possess a least amount of the workload while they used the duration *and* rhythm based encoding.

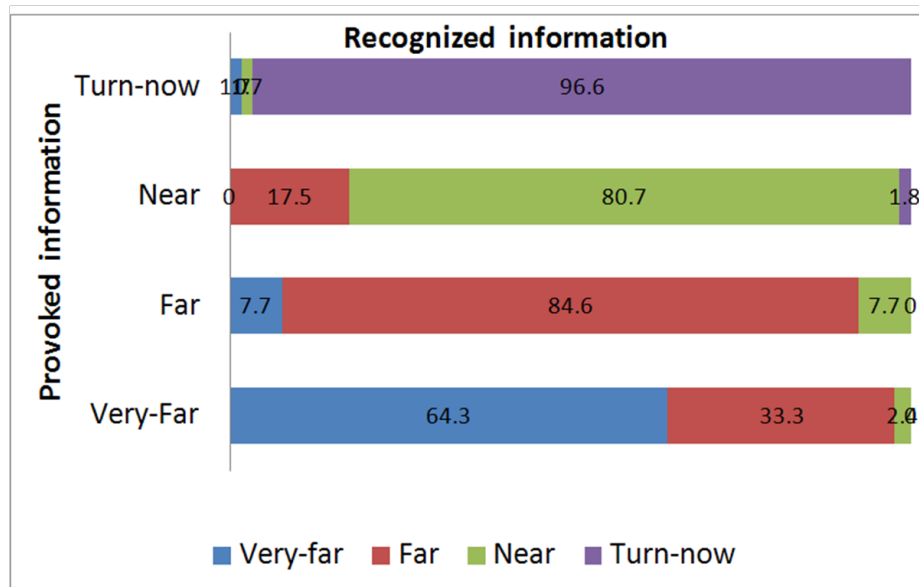

Figure 4.32: Drivers’ recognition of distance categories in the rhythm based distance encoding.

Engagement with the Environment

We observed from the videos that the vibrotactile feedback did not cause any visual distraction. In each driving session, the participants were freely commenting about the houses and shops on the way. The participants stand no obstruction in thinking aloud and using the tactile display simultaneously. The drivers discovered the vibrotactile feedback to be quite helpful while talking to the other passengers and concurrently searching a specific location in the city. The participants do not need to slow down the speed of the car to recognize and understand the vibrotactile feedback. In total, the participants missed out 3 out of 221 turns in the whole experiment. A participant commented that *"I have enjoyed this drive, because the system was not grabbing my attention at all"*.

Visual and Auditory Modalities

In the responses to questions regarding the overall impression of the prototype 85% of the participants told that they like the vibrotactile signals for displaying direction and distance. The idea of replacing the auditory feedback with the tactile feedback is preferred by 93% of the participants. The participants commented

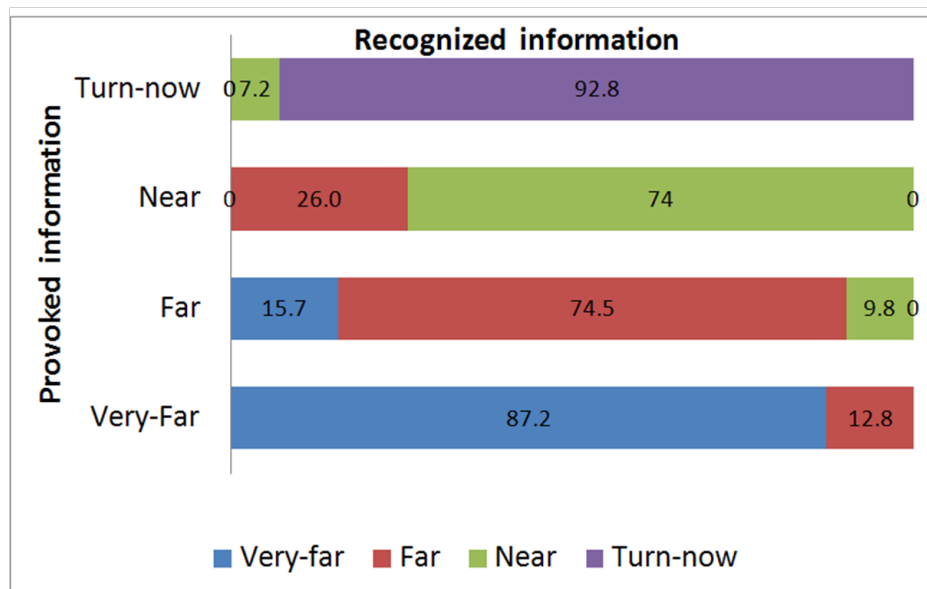

Figure 4.33: Drivers’ recognition of distance categories in the rhythm *and* intensity based distance encoding.

that the tactile feedback was less irritating than the auditory feedback. The tactile interface is preferred for directional information by the participants. Two participants told that they would prefer to have a visual display with the tactile display. So, the visual displays can help in such situations when the participants are not confident about the tactile signal.

Driver’s Distraction

No visual distraction is evident from the video analysis and the experimenter observations. We observed that in the rhythm based distance encoding, the maximum intensity used to present all categories of distance was irritating for the drivers of the car. In the rhythm *and* intensity based distance encoding, a lower intensity to indicate *vary-far* and *far* is liked by the participants. One participant told *"I will prefer lower intensity to present longer distances because it's not disturbing"*. Another participant commented *"It is good to present very-far and far with low intensity signal to get warning before the next turn"*.

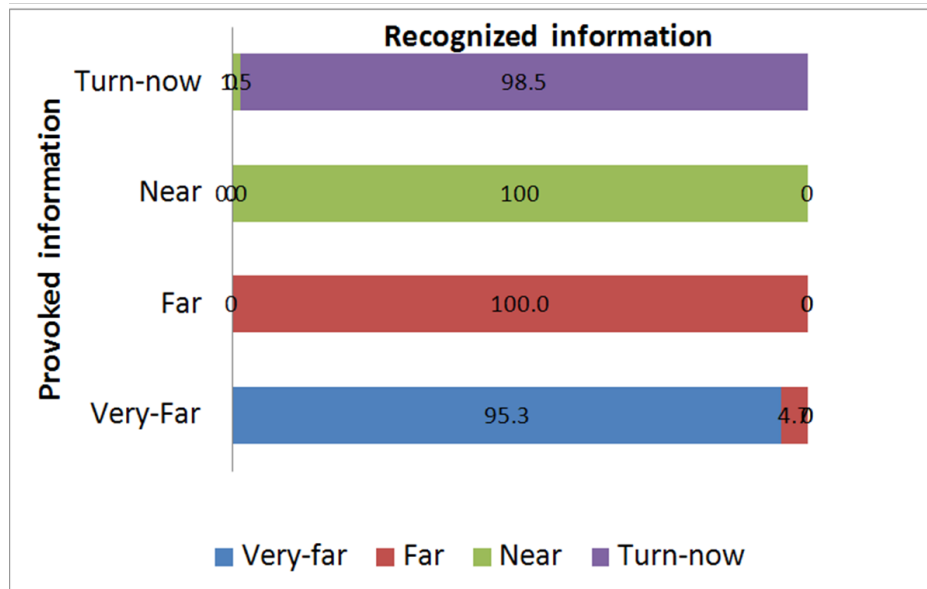

Figure 4.34: Drivers’ recognition of distance categories in the rhythm *and* duration based distance encoding.

Categories of Distance

The participants told that they could easily differentiate the vibrotactile signals of *very-far* and *far* with *turn-now*. The participants preferred to get the signal of *turn-now* very close to the turning. We observed that the smooth signals for the distance *very-far* and *far* were less irritating for the participants. One participant did not feel the *very-far* signal in the rhythm and intensity based distance encoding twice. The participants told that they were certainly interested in the distances *near* and *turn-now*. In addition, the participants responded that it was good to have *very-far* and *far* signals in advance, so they would get attentive for upcoming turn.

4.4.5 Discussion

The tactile interface is certainly helpful in the situations when it is very risky to put the eyes off the road. The participants found the tactile feedback useful, less irritating, and safe for the car navigation systems. The rhythm *and* duration based distance encoding, which supports the concept of countable pulses, is the most successful among all the tested designs. The results show that the rhythm *and* duration design is significantly more usable than the other two designs. The

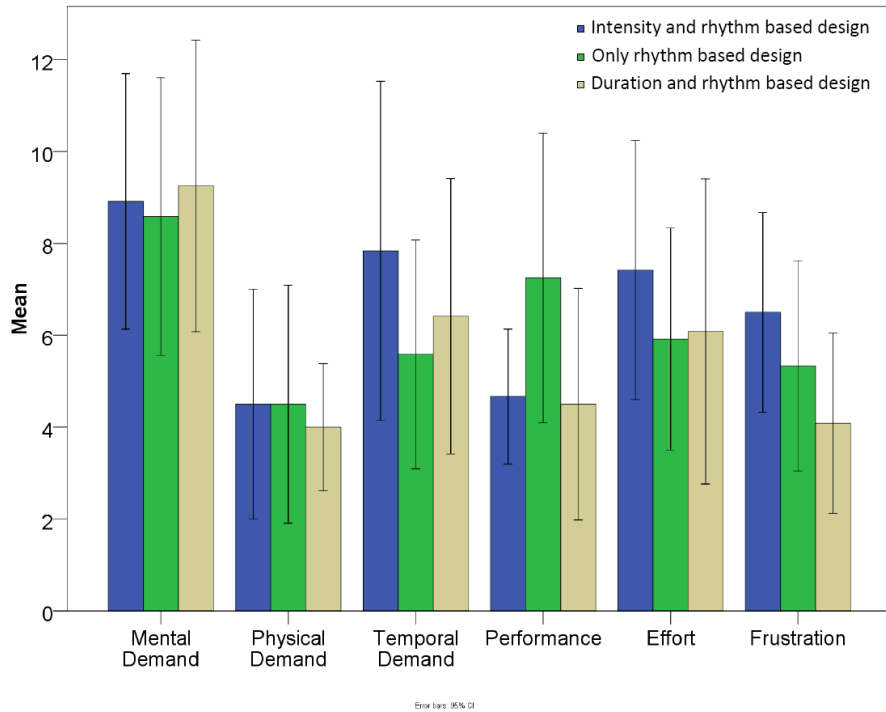

Figure 4.35: Workload on drivers while driving on all three vibrotactile designs.

driver made considerably less errors in perceiving distance information. It is, therefore, discovered as an appropriate approach to encode distances through the vibrotactile signals. In the following, the results regarding our research questions for this study (Section 4.4.3) are discussed.

Q1: Will the participants perceive turn-by-turn distance information without support of the visual and auditory modalities in the car?

The participants missed the crossing only 3 times in the whole experiment which supported the argument that vibrotactile signals could be used to present the distance information for the whole route while driving. We concluded from the qualitative results that the participants asked for the visual display in case they were not sure regarding the meaning of the vibrotactile signal. The findings like engagement with environment and the participants' preferences to the tactile display support the fact that tactile feedback with no visual and auditory attention is beneficial for providing navigation information in many situations. So, we determined that the vibrotactile signals could be qualified to present spatial information

in the car navigation system.

Q2: Which one of the encodings – rhythm, rhythm *and* intensity, rhythm *and* duration – is the most usable encoding?

The results show that the rhythm *and* duration based distance encoding is proved to be more usable among all the tested designs. The similar vibrotactile patterns were found best for the judgment of distance information by users in [PKB10]. In addition, it is easier for the driver to learn the distance information in rhythm *and* duration based distance encoding as compared to the other encodings. The concept of countable pulses for encoding distance information is quite distinct from previously proposed schemes [EV01, EVJD05]. The results demonstrated that the most usable design was based on the countable pulses for the car navigation system. Furthermore, the participants believe that afterward they could also gain confidence on the vibrotactile rhythm based distance encoding approach with more practice.

Q3: Which distance encoding helps the driver make the least number of information perception / interpretation errors?

The participants made the least number of errors on the rhythm *and* duration based distance encoding compared to the other two designs. Besides rhythm, the duration of the vibrotactile signal plays an important role in the vibrotactile distance encoding in the car. The simplicity of the vibrotactile information encoding information allowed the drivers to easily recognize the meaning of the signal. The two designs, rhythm based distance encoding, and rhythm *and* intensity based distance encoding are composed of similar rhythm patterns with different levels of intensity. In both designs, the results differ insignificantly terms of mistakes of the participants in perceiving distances. So, we concluded that modification in the level of intensity did not impact significantly on the perception of distance in the designs. We also observed from our qualitative results that the lower intensity was less irritating for a longer distance. In summary, the approach of rhythm *and* intensity based distance encoding can be beneficial in some aspects (e.g. for longer distances, a lower frequency is not disturbing), but the approach of intensity based distance encoding is not mainly contributing. The results support the concept of quiet communication in the car proposed by [EV01]. The results encourage the use of tactile display for complex information in the car navigation systems besides the fact that the drivers need backup support of the visual and auditory modalities [KMH⁺09].

Q4: What are the common errors that the participants commit to interpret the distance information by using the tactile display?

The drivers tended to make the least number of errors while they got oppor-

tunity of counting the number of pulses. In general, we can observe from the quantitative and qualitative results that most of the times, the participants face difficulty in distinguishing vibrotactile signals for the two adjacent categories of distance. Most of the errors are evident in the rhythm based distance encoding. Similarly, the qualitative results show that the participants were unable to feel the vibrotactile signal with a lower intensity. The participants sometimes do not perceive the vibrotactile signals of a lower intensity because of vibration of the car. From qualitative results, we can conclude that the tactile display does not imply any visual distraction, thus, the drivers are able to fully concentrate on the primary driving task. Our findings support the fact that the tactile displays in the car navigation systems cause less amount of distraction to the driver [EV01].

The results of the experiment can only be applied to the street scenarios. The distances are decided for categories of *very-far*, *far*, *near*, and *turn-now* while driving in a residential area. The vibrotactile signals were controlled by the experimenter, so we could neglect the chance of human error in the experiment. The gender aspect is also a limitation of the study because mostly male participants have taken part. The results cannot be generalized for the old drivers.

4.4.6 Summarizing the Turn-by-turn Direction and Distance Presentation with the Tactile Display

From the previous studies [HVEK09, EV01] we may have assumed that tactile feedback can be used as an alternative way to present the direction and distance information to the driver without support of the visual or auditory displays. In Section 4.2, we conducted a survey to find if the tactile belt was acceptable for the presentation of navigation instructions in the cars. The results of the survey are evident of acceptance of the tactile belt in the car navigation system. The tactile belt is significantly acceptable according to the technology acceptance model, although, the users did not like the continuous presentation of the vibrotactile signals for perceiving the direction information.

We explored the tactile parameter of the body location to encode the direction presentation in the car navigation systems in the Section 4.3. The pilot study in Section 4.3.1 showed that the body location was a valid parameter to present the direction information in the car. We exploited different alternatives of vibration on the body locations in Section 4.3.2, and *two vibrators font encoding* shown in Figure 4.11 was most suitable construction to present direction with the tactile display in the cars.

In order to present distance information, we examined the tactile parameters of rhythm, intensity, and duration in a number of combinations in Section 4.4. In Section 4.4.1, we extracted the suitable constructions of the tactile parameters. We found the three suitable combinations of the tactile parameters i.e. rhythm only, rhythm *and* intensity based design and, rhythm *and* duration based design. In Section 4.4.3, we compared these designs in an evaluation which we conducted on a real navigation scenario in an urban environment . We found that the rhythm *and* duration based encoding shown in Figure 4.24 was the most suitable among all to present the directions in the car. By this design, the driver receives a tactile stimulation through the countable vibration pulses which encode the distance information. We can conclude that the approach can be applied to encode the distance information in the most complex road scenarios. Our discovered vibrotactile designs for presenting the direction, and distance information in cars are exploitable on scenarios explained in Section 4.1.

Our studies show that the tactile feedback is quite helpful for the navigation in the environment without support of the visual or auditory displays. The present studies are, however, carried out in the urban environments and it is not clear, whether the results can be generalized for the other environments, such as motorways or highways. Furthermore, how have the distance categories to be adapted to other scenarios?

This chapter provides a proof of the assumption that the direction and distance can be presented with the tactile display from the relative position of the fast moving objects. The design of the vibrotactile signals for the presentation of direction and distance information might be adapted by the industry to design vibrotactile signals for the presentation of route information. Information presentation in the cars is currently a topic of high interest in the public and transportation industry. On the one hand, there is a huge demand from the end users' point of view to ease the ability to move from the one location to another with more safety and comfort. On the other hand, new technical developments allow advanced and innovative interaction techniques in the cars, which will be an important argument for buying cars in the future. Tactile displays will have a great impact on the future developments in human machine interface design of automobiles.

4.5 Summary

In this Chapter, we explored the vibrotactile feedback for navigation information in the cars. We examined the tactile belt for the drivers' acceptance to present the

navigation information in the cars. We found the tactile belt to be an acceptable interface for navigation help in the car.

Direction and distance are two important factors required to present for the navigation information. It is discussed in the Chapter 3 that on different types of road intersections, the drivers needed to know "*where to turn next after how long?*". In one study, we discovered the tactile parameters suitable for presenting the direction information. We found that the body location is the best suited for presenting directions to the drivers with the tactile belt.

We studied the tactile parameters suitable for presenting the distance information and way to present the tactile signals. We exposed that rhythm and duration were the best suited vibrotactile parameters for presenting the distance information.

In addition to the vibrotactile designs, we successfully measured the usability of the tactile display. We applied the methodologies for evaluating the tactile display. This might set the strategy for examining the vibrotactile display in the future research. The findings will help design the tactile based navigation aid for the users other than the drivers, such as the pedestrians, the cyclists, and the blind. The results are beneficial for the car industry to build the navigation systems using a new modality. The tactile interface is quite acceptable for the users in different road condition for getting the navigational aid.

Chapter 5

Tactile Design for Presenting Roundabout Information

Roundabouts are among one of the types of road intersections. The roundabouts are getting popular for maintaining safety around the world and especially in Europe. In year 2008, it was estimated that half of world's roundabouts exist in France [Gui08]. In 1950, the first roundabout constructed and existed in the city of Muenster, Germany [Bri08]. With the passage of time, the roundabouts are built in many urban and rural roads. Currently, the roundabouts are one of the essential road intersections. There is a lot of work going on several roundabout designs, planning, and policy development.

These roundabouts are getting essential for the urban roads because of their safety and capacity characteristics. There is a need to explore the vibrotactile signals for displaying roundabouts intersection for fully functional tactile-based navigation system. Section 3.3 described that the navigational information required to display on roundabouts was different than just showing the direction and distance in conventional turn-by-turn route guidance. In the driving process on a roundabout intersection, a driver needs to first enter inside a roundabout, move around a circle, and take an exit on intended lane. The study reported in this chapter, addresses the observations that we made to design and encoding of vibrotactile signals for presenting the roundabout information to a driver.

In this chapter, we first examine the existing roundabouts intersection. We identify the information that is needed by a driver to cross the roundabouts. We explore the designs of vibrotactile messages for displaying the identified information. We conduct a study to evaluate the vibrotactile messages in order to find the best suited design to display the information regarding roundabout intersection in

the car.

Structure of this chapter

In this chapter, we explore the vibrotactile design for presenting the roundabouts information in the car navigation system. Figure 5.1 shows a structure of this chapter. Section 5.1 gives an overview of a roundabout intersection. In this section, we describe a scenario of crossing a roundabout intersection by using the tactile display and steps involved in crossing this intersection. The information required to present with the tactile display is identified in this section. Section 5.2 illustrates the tactile parameters that can be used to encode a roundabout information in the car navigation system. This section explains the preliminary study to explore the tactile parameters to design the roundabout information. Section 5.3 presents the appropriate vibrotactile designs for displaying a roundabout information in the car navigation systems. In Section 5.4, we conduct an evaluation to compare different vibrotactile designs in order to select the best suitable design for presenting the roundabout intersection in the car. Section 5.5 shows the results of our evaluation. In Section 5.6, we discuss the results of our evaluation. We will close our chapter in Section 5.7 with the summary of this chapter. Parts of this chapter are published in [BAH11].

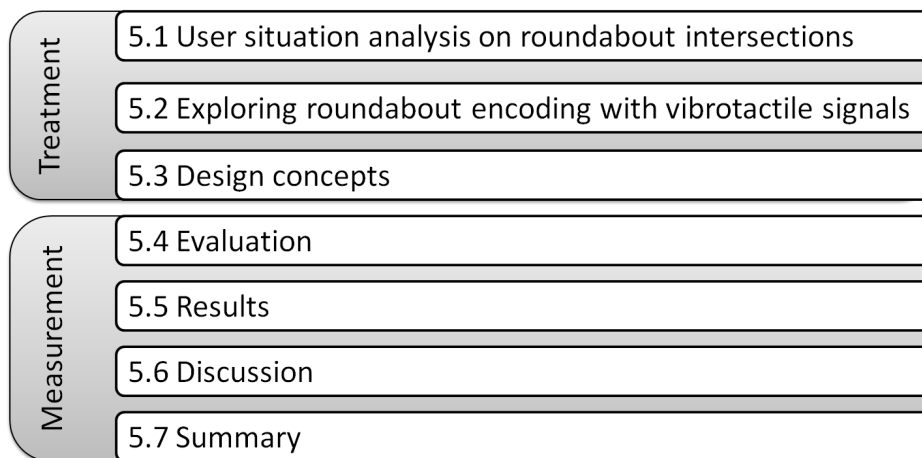

Figure 5.1: Overview of Chapter 5.

5.1 User Situation Analysis on Roundabout Intersections

Roundabouts are very common intersections on the urban roads. These intersections are preventing the circular traffic from locking up by not allowing the traffic to enter until there is a sufficient amount of gap into the road. Roundabouts can be divided into six different categories [Rob00]: (1) mini-roundabouts, (2) urban compact roundabouts, (3) urban single-lane roundabouts, (4) urban double lane roundabouts, (5) rural single-lane roundabouts, and (6) rural double-lane roundabouts.

Mini roundabout is a small roundabout that exists in low speed urban roads. These roundabouts exist at such roads where conventional roundabouts are not allowed to build. Mini roundabout is inexpensive in terms of space.

Urban compact roundabouts' behavior meets all the requirements of an effective roundabout. These roundabouts are pedestrian and bicyclist friendly because of their perpendicular approach legs and require a very low vehicle speed.

Urban single-lane roundabout consists of a single lane entry at all legs, and one circulatory lane. These types of roundabout have a larger inscribed circle, more entries, and exits. A car is required comparatively higher speed at entry, inside the roundabout, and at exit.

Urban double-lane roundabout includes all types of roundabouts which have at least one entry with two lanes. These roundabouts are built to accommodate more than one vehicle traveling side by side, and require wider circulatory road ways.

Rural single-lane roundabout and rural double-lane roundabout - both have generally high approaching speeds. Single entry, single lane circular path, and single exit are characteristics of the rural single-lane roundabout. Whereas, the rural double-lane roundabout contains at least two entry lanes, two lanes inside roundabout, and two exits from the roundabout. Both types contain a larger diameter to accommodate a large amount of circulatory traffic.

In this chapter, we address a vibrotactile information presentation on mini, compact, and urban single-lane roundabout. Since, these types of the roundabout having characteristics of single lane entry at all legs, one circulatory lane, and located in urban areas. The vibrotactile design on these roundabouts will provide the basis of tactile information presentation on the roundabout with more complex structure. In order to identify the information required for the route guidance on roundabouts, we considered the following scenario.

5.1.1 Scenario of Crossing a Roundabout

We use a tactile belt to provide roundabout information to the driver. Figure 5.2 shows an example of how vibrotactile signals can be provided to the driver through the tactile belt when approaching the roundabout. The tactile belt points to the right-hand direction to present information regarding entering and exiting the roundabout to the driver. The driver will perceive the vibrotactile signals, interpret the information, and decide to take the indicated exit.

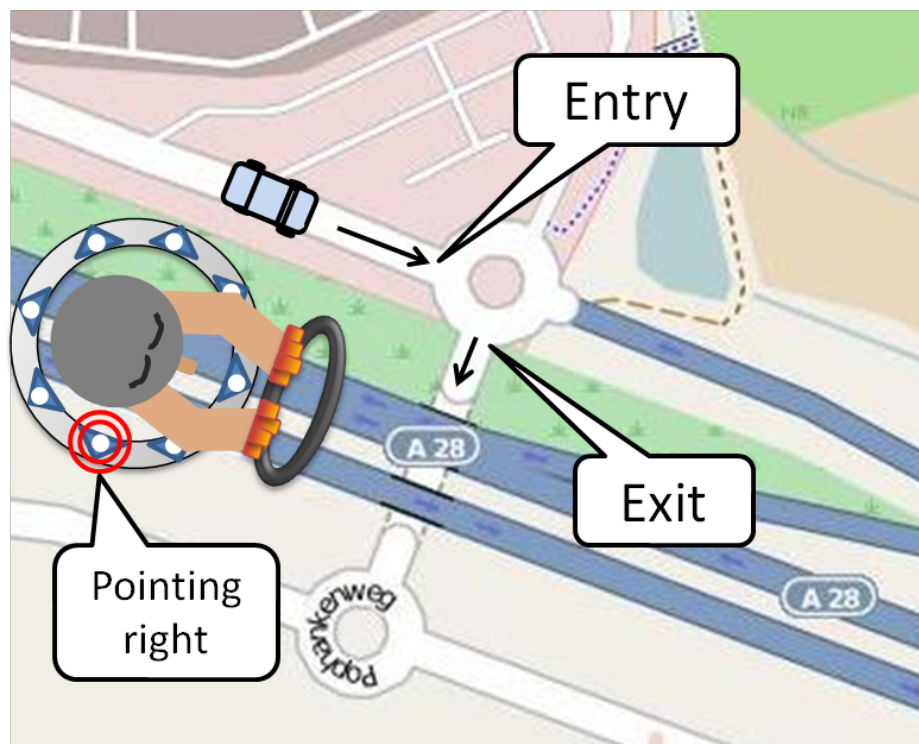

Figure 5.2: Take the first exit which is on the right with respect to the entry point.

In order to present the roundabout information with the help of a tactile display, we investigated the research questions like:

1. Which information do we need for displaying a roundabout intersection?
2. Where is the suitable location to present this information?
3. How to present that information with the help of a tactile interface?

In order to answer the above questions, we consider the following information from two perspectives (1) the tactile display, and (2) a driver:

- *The tactile display:* The information required to present using the tactile display is dependent on the appropriate time when exactly information is required to be presented. How the vibrotactile messages feel to a driver regarding next roundabout intersection. The structures of vibrotactile patterns for displaying different locations of a car, such as roundabout is approaching or take exit, with respect to a roundabout. Which information are appropriate to display with vibrotactile messages among: (1) car is closer to next intersection, (2) the intersection is roundabout after "x" meters, (3) the car entering into the roundabout, (4) exit to take, (5) exit here, and (6) the car took a correct exit.
- *A driver:* A driver needs to know that next intersection is roundabout after "x" meters. He also requires information for reducing the speed of a car, taking a correct lane, entering in the roundabout, knowing which exit to take, turning car to desired exit, and knowing exit from the roundabout successfully.

In this Section, we explore information required to encode with vibrotactile signals for displaying roundabouts with a car navigation system. In the next sections, we look at the types of roundabouts, and steps of crossing the roundabout.

5.1.2 Crossing Roundabout Intersections

We address a vibrotactile information presentation on mini, compact, and urban single-lane roundabout. Since, these types of roundabout had characteristics of single lane entry at all legs, one circulatory lane, and located in urban areas, the vibrotactile design on these roundabouts would provide the foundation to a vibrotactile information presentation on the roundabout with more complex structure. In order to identify the information required for route guidance on roundabouts, we considered a number of steps of crossing the roundabout shown in Figure 5.3.

1. Roundabout indication: A driver requires to be informed about a roundabout intersection. This information will help a driver to know the type of a crossing in advance.

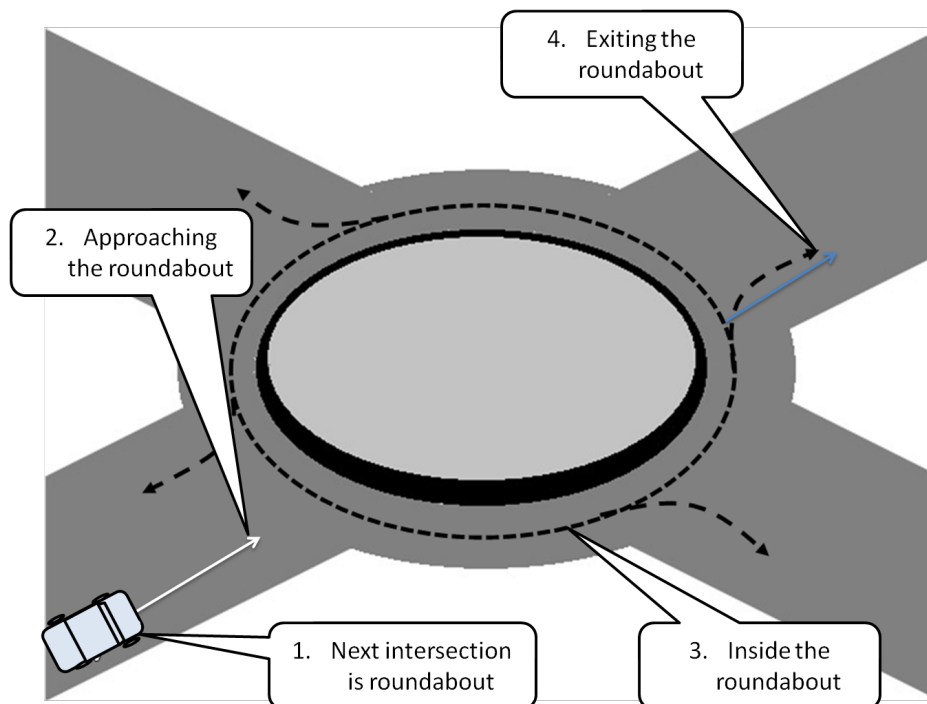

Figure 5.3: Different stages of crossing a roundabout.

2. Approaching roundabout: While the driver approaches to roundabout, information about the exit can be presented to the driver before entering the roundabout. In conventional car navigation system this information can be presented via visual or auditory display. Visual display shows the direction of the exit. Auditory display conveys the exit which car is required to take (e.g. take second exit).
3. Information presentation within the roundabout: While driving within the roundabout the driver needs some information on the actual exit to take. This information will help the driver if he missed, forgot, or misinterpreted the roundabout information signals before entering.
4. Exiting the roundabout: If the driver missed the correct exit, it is possible to recalculate the route information. In our research, this information is not required to present with vibrotactile signals to the driver after exiting from a roundabout.

The above steps of crossing a roundabout are considered for vibrotactile design of presenting roundabout information. The tactile parameters are investigated to present roundabout information.

5.2 Exploring Roundabout Design with Vibrotactile Signals

Rhythm, duration, intensity, and body location are tactile parameters that can be used to encode vibrotactile messages to present navigation information. These tactile parameters can be modified to present roundabout information to a driver. To find the most suitable tactile parameters in order to encode the roundabout information, we proposed initial vibrotactile designs and evaluated their feasibility in a preliminary study with a small number of participants. Aim of the preliminary study was to identify the type information required to present on roundabout, a design of vibrotactile message to display identified information, and sequence of presentation of this information. We used a tactile belt for vibrotactile information presentation on roundabout. The driver wears the tactile belt (see Section 4) shown in Figure 5.4 around his waist. In the following, we explain the most promising vibrotactile designs for presenting information on Step 1-3 (see Section 5.1.2), while crossing the roundabout.



Figure 5.4: Vibrators location on the tactile belt used in experiments.

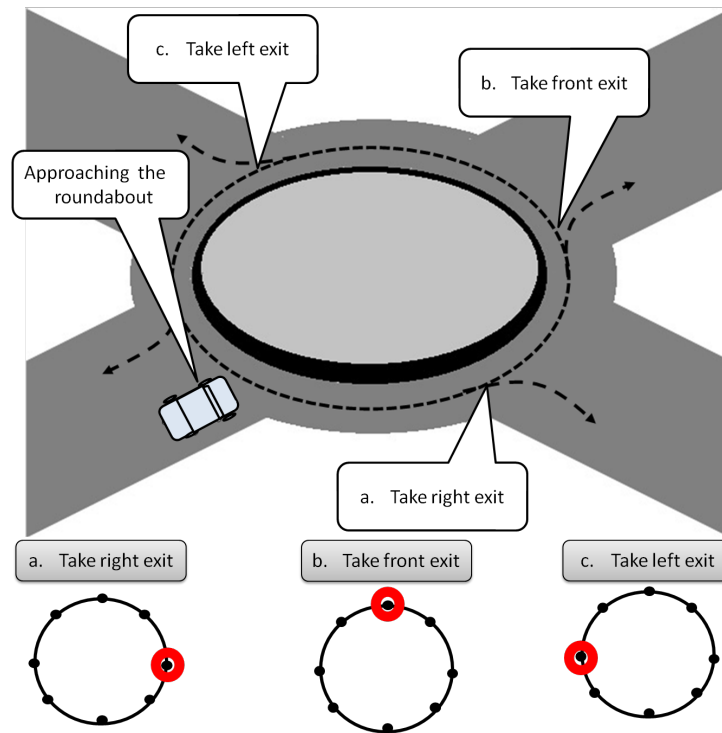

Figure 5.5: Vibrotactile design based on the concept of the typical visual display in conventional navigation system for conveying the n-th exit of a roundabout into a certain direction (direction-based design).

1. *Roundabout*: The eight vibrators of the belt turn on and off in anticlockwise direction around the waist of the driver for one second to indicate that the next intersection is roundabout. This vibrotactile signal shows the type of intersection and helps a driver to prepare for a roundabout intersection.
2. *Information signals*: In this Step we present the vibrotactile signals to the driver to convey an exit to take. We proposed four different vibrotactile designs for information signals: (1) *direction-based*, (2) *count-based*, (3) combine i.e., both *direction and count based*, and (4) *distance-based*.

The vibrotactile design which is based on the rules of visual display in a conventional car navigation system, is named as *direction-based*. In *direction-based* design, the tactile belt points to the direction of the *exit* to visualize a particular exit to take before the car actually enters the roundabout shown

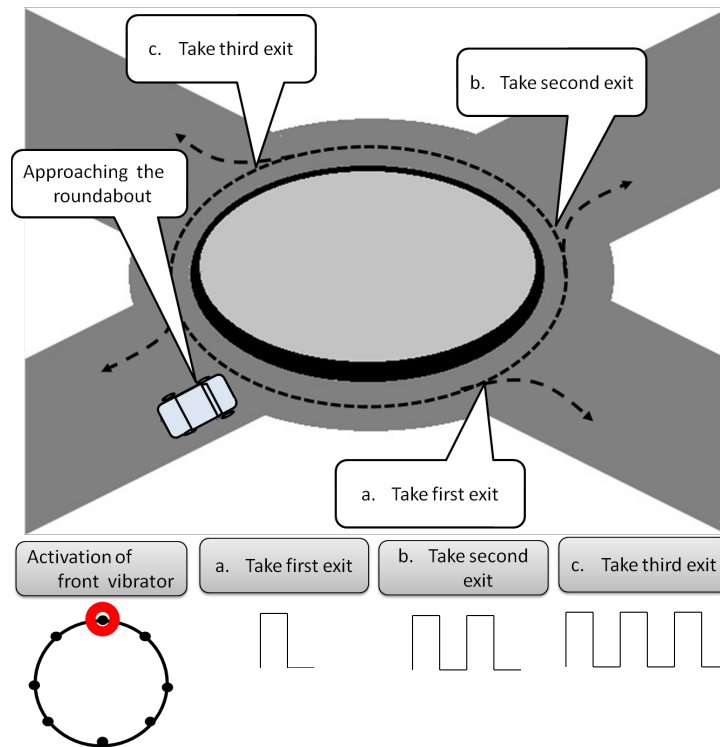

Figure 5.6: Vibrotactile design based on the concept of typical auditory announcements in conventional navigation system for taking the n-th exit of a roundabout (count-based design).

in Figure 5.5.

The vibrotactile design which is based on the rules of auditory navigation instructions is named as *count-based*. In *count-based* design the tactile belt vibrates in the form of countable pulses shown in Figure 5.6. The count of the vibration pulses is equal to the count of the exit to take, e.g. two pulses means second exit.

We combined both, the direction and the count based design into *direction and count based* (see Figure 5.7). In this design, a count of vibrotactile pulses is equal to the number of exit to take i.e., similar to the count based design. The tactile belt vibrates in the direction where exit is located with respect to the current position of a car similar to the direction based design. Vibrotactile signals will, therefore, convey that the driver is required to take

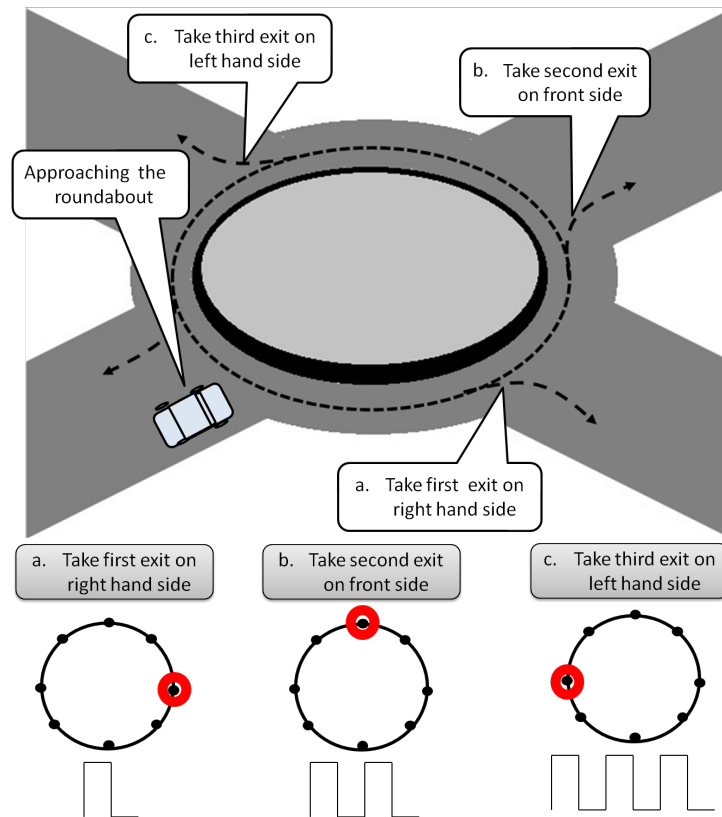

Figure 5.7: Vibrotactile design based on the concept of typical visual and auditory information in conventional navigation system for navigating through the roundabout (direction-based-and count-based design).

a particular exit which is location in specific direction relative to the current position of a car.

In distance-based design, we presented distance of a car from the *exit* with the help of vibrotactile signal. For this, we followed the approach of [AHB10] which was used to encode vibrotactile signals for presenting distance of a car from the intersection. In this approach, the distance was divided into the four categories *very-far*, *far*, *near*, and *turn-now*. Four pulses, three pulses, two pulses, and one pulse indicate *very-far*, *far*, *near*, and *turn-now* distances respectively. In order to present a roundabout crossing, we also divided distance of a car from the exit of a roundabout into four categories. We presented *very-far* distance from a roundabout exit with four

vibrotactile pulses, *far* distance with three pulses, *near* with two pulses, and *exit-now* with one pulse.

3. *Inside the roundabout*: At this step, we presented a single but powerful vibrotactile signal length of 1 second to indicate *exit-now*. This Step will help the driver to get confirmation that he or she is required to take exit now.

We combined different vibrotactile designs to propose initial designs for displaying the roundabout crossings. We proposed six different vibrotactile designs for displaying the roundabout intersection to a driver: (1) *roundabout+direction-based*, (2) *roundabout+count-based*, (3) *direction-based+inside the roundabout*, (4) *count-based+inside the roundabout*, (5) *roundabout+direction and count based+ inside the roundabout*, and (6) *distance-based* design. We conducted a preliminary study to compare these designs and discovered more vibrotactile presentations on roundabouts.

5.2.1 Participants, Apparatus, Design, and Procedure

Two male participants, 24 years and 32 years old, have taken part in the study. Both have, on average, 10 years of driving experience. We used a Volkswagen Touran car to conduct the study on urban single-lane roundabouts. We recorded the participants' videos, captured their voices, and interviewed them for data collection. Our preliminary study contained one independent variable, i.e., roundabout information presentation to the driver with the help of vibrotactile signals.

We compared six different vibrotactile designs: *roundabout+direction-based*, *roundabout +count-based*, *direction-based+inside the roundabout*, *count-based+inside the roundabout*, *roundabout+direction and count based+inside the roundabout*, and *distance-based* design in the six sessions of driving for displaying the roundabout information to the drivers. Each participant has to drive for all the designs combinations in different driving sessions. We interviewed the drivers after each driving session to know their preferences on the vibrotactile design, performance, design impression, and body location.

We trained the participants on all the vibrotactile designs. On the venue, the participants were reminded about the vibrotactile signals combination before starting each session. The experimenter, seated next to the driver, was controlling the tactile signals. The participant was following the route according to the vibrotactile instructions, and announcing aloud the meaning of vibrotactile signals. After

finishing the first session, the participant was interviewed. Subsequently, the participant was trained on the next design before starting the next session, and so on. Each of the participants drove in a multiple number of sessions.

5.2.2 Results and Discussion

The qualitative data was collected with the help of video recordings and interviews. The videos were analyzed post experiment. In the following, we explain the participants' responses on different dependent variables.

Preferences: "*Direction-based* roundabout signal provided me with a global view about the direction to take exit, and when it combined with exit-now signal, then it would be the best, even in context of bigger roundabouts." "The best design for me was to have a *roundabout* signal followed by *count-based* roundabout design and *inside the roundabout* for exit-now signal." It means that vibrotactile information presentation on Step 1-3 is required for the route guidance of a driver.

Performance: The participants told that they performed very well on *direction-based* and *count-based* roundabout vibrotactile design. On *distance-based* design, the participants got confused. *Distance-based* design was not helping at all on roundabout intersection according to the participants' view. So, we exposed that distance information was not required in vibrotactile presentation of a roundabout.

For *direction-based* design, the two participants told, "This design helped to estimate the direction of exit; in particular, when I can see the direction of the exit across the roundabout." "The *direction-based* roundabout design is better than the *count-based* roundabout design." "The *direction-based* roundabout design helped me when it indicated the first exit on the right hand side then I entered, and exited on right." We included the *direction-based* design in our further designs on the basis of participants' responses.

According to the participants, the *count-based* design has both pros and cons. "It is not easy to remember the count of pulses while driving." "The *count-based* roundabout design can help in situations where the roundabout circle contains a higher surface." So, we decided to integrate *count-based* design in our further vibrotactile designs for roundabout presentation.

The participants rejected the idea of presenting distance information on roundabout. "I do not like the presentation of distances on the roundabout as it is more distracting from the driving task." "Distance presentation is not really needed in this context." So, we discarded the presentation of distance information in further vibrotactile designs for roundabout presentation.

Body location:

The participants were comfortable with sensing the roundabout signal around their waist. The participants did not like the countable tactile sensations on the back. "In *count-based* roundabout design, the vibrotactile signals on the back side of the body are not intuitive; I would like to have it on the front of my body." The body locations in *direction-based* roundabout design are suitable for the both participants.

The study showed that in general the participants preferred to have:

1. *Roundabout* indication
2. The informational signal about which exit to take
3. When the car is entered the roundabout then the *inside the roundabout* signal

The participants liked to have *direction-based*, *count-based*, and *direction and count based* roundabout signals for displaying the exit information, while a car was approaching the roundabout. This study helped us to find three appropriate vibrotactile designs for presenting roundabout information i.e., (1) *roundabout & direction-based & inside the roundabout*, (2) *roundabout & count-based & inside the roundabout*, and (3) *roundabout & direction and count based & inside the roundabout*.

One limitation of the study was that it was carried out with only two participants. The participants' comments and suggestions, however, helped us a lot to improve our vibrotactile designs for presenting the roundabout intersections.

We discovered three different vibrotactile designs for displaying roundabout information in the result of the preliminary study. Nevertheless, on given the number of participants and the qualitative results of our preliminary study, we cannot decide one appropriate vibrotactile design for displaying roundabout in the car. In order to investigate one best suitable vibrotactile design to present roundabout information, we are required to conduct a comparative evaluation on the basis of performance, usability, and cognitive workload of drivers. In the following, we explain three conceptual designs based on our preliminary study.

5.3 Design Concepts

In the preliminary study, we found that the parameters of tactile, such as rhythm, duration, and body location are suitable to encode vibrotactile signals for display-

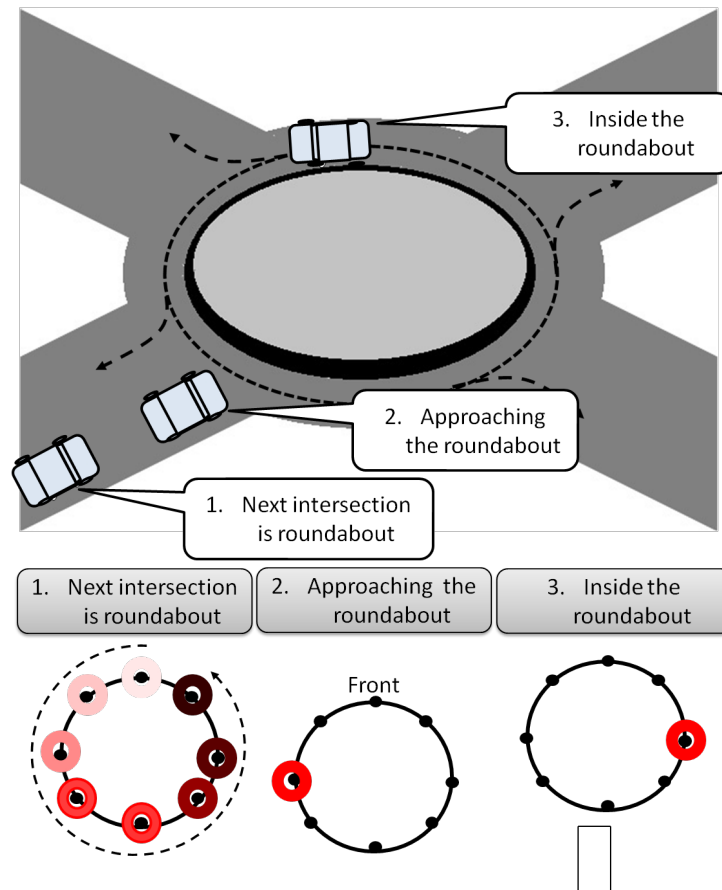

Figure 5.8: Visualization of *direction-based* design.

ing the roundabout information. The parameter of body location is used in the *direction-based* design. The *count-based* design is developed with the help of duration and rhythm parameters. We used the parameters, such as body location, rhythm, and duration in *direction-and-count-based* design. Each of the designs is composed of vibrotactile information presentation on Steps 1-3 in Section 5.1.2.

Direction-based design: In this design, shown in Figure 5.8, the vibrators of the tactile belt activate one by one in anti-clockwise direction around the belt for 1 s (second) to indicate Step 1 in Section 5.1.2 i.e., roundabout indication. In Step 2 of "approaching roundabout" the vibrator gets activated in a specific direction for 1s to visualize the driver to take the respective exit in that specific direction. One pulse informs a driver to take an exit just before an intended exit when a car

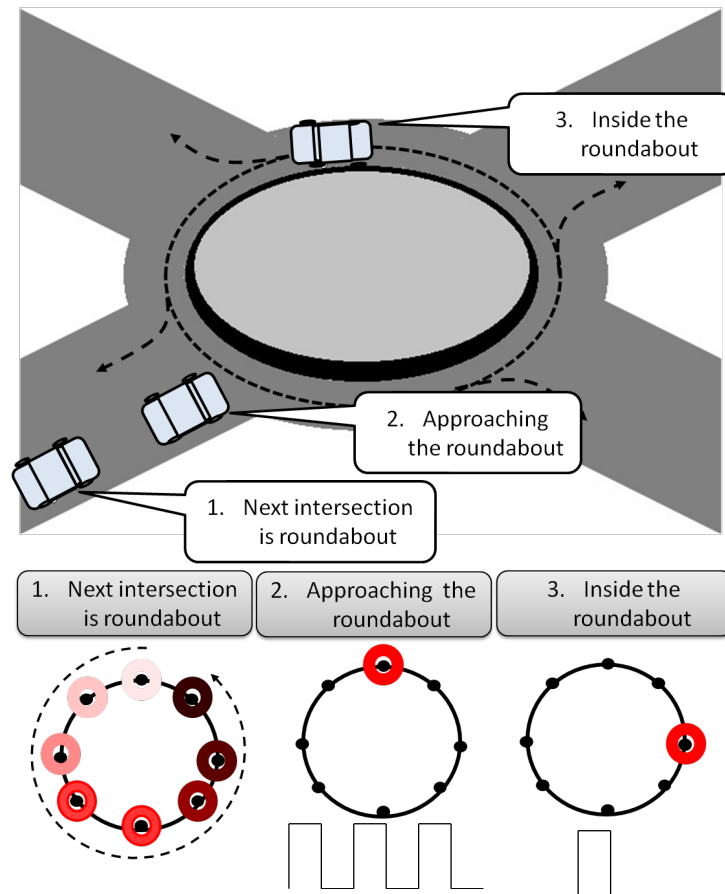

Figure 5.9: Visualization of *count-based* design.

enters the roundabout in Step 3 "information within the roundabout."

Count-based design: Similar to the previous design, the roundabout signal is activated for 1s in Step 1. In Step 2, the vibrator located on the front of the belt is activated in the pattern of countable vibrotactile pulses. A count of vibrotactile pulses is equal to the number of the intended exit to take. Finally in Step 3, when a driver enters the roundabout, the one vibrotactile pulse is triggered on the right side of the belt to inform the driver about the intended exit to take. Figure 5.9 presents the count-based design.

Direction-and-count-based design: This design is a combination of direction-based and count-based designs (see Figure 5.10). In direction-and-count-based design, first the vibrotactile signals are activated to display "next

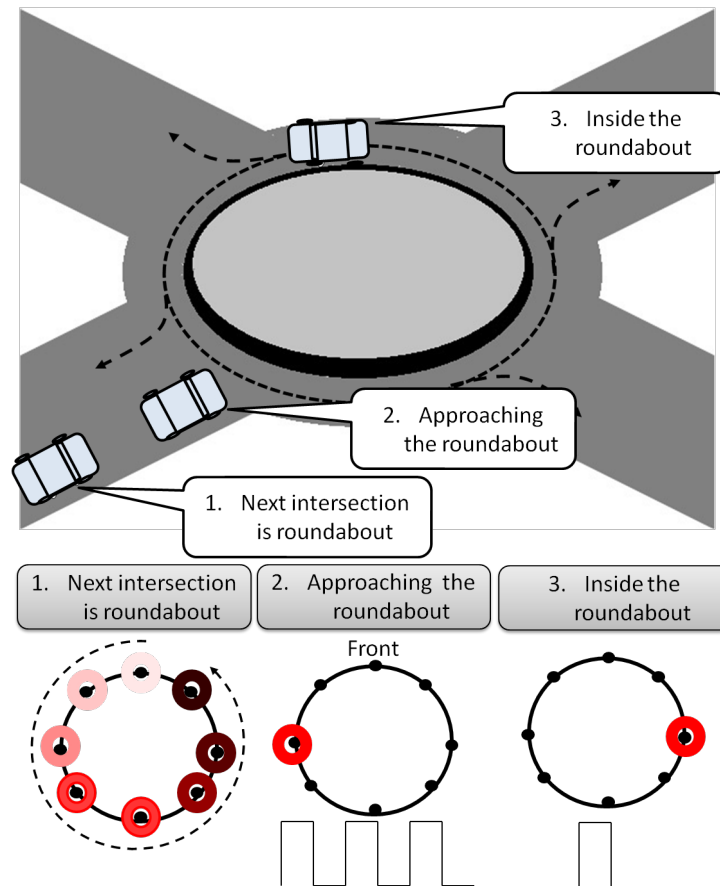

Figure 5.10: Visualization of *direction-and-count-based* design.

intersection is roundabout." Subsequently, the vibrators are activated in the direction of exit with respect to current position of the car to display "direction to take exit." Concurrently, in order to indicate "a number of exit to take" with respect to entry lane of a car inside the roundabout the vibrotactile pulses triggered in the form of countable pulses, which was equal to a number of exit. When the car entered a roundabout the *exit now*, the signal activated to inform the driver about that particular exit.

The preliminary study determined that the *direction-based*, *count-based*, and the combination of *direction-and-count-based* approaches could be successfully used to encode roundabout information with the vibrotactile signals. We need to discover the most usable design among all for presenting the roundabout intersection in the car navigation system. In the following, we evaluate the *direction-*

based design, *count-based* design, and *direction-and-count-based* design to find the most suitable combination of vibrotactile signals to present the roundabout intersection.

5.4 Evaluation

In the preliminary study, we derived the tactile parameters to display roundabout with the tactile belt to a driver. We discovered the three suitable vibrotactile designs (see Section 5.3) for presenting a roundabout in a car navigation system. In order to find one appropriate vibrotactile design, we conducted an experiment to compare the derived vibrotactile designs to present a roundabout intersection to a driver in a car navigation system. We carried-out an evaluation on the real urban roundabout near the shopping area of a city.

We evaluated the vibrotactile designs on the factors of ranking, usability, performance, and cognitive workload in the experiment. Our comparative study investigated the following questions:

Q1: Can drivers successfully perceive and interpret the vibrotactile signals that display the roundabout intersection?

Q2: Which of the designs – direction-based, count-based, and direction-and-count-based – is most suitable for presenting the information on roundabout intersection?

Q3: Among – direction-based, count-based, and direction-and-count-based - designs, which is most usable for presenting the information on roundabout intersection?

Q4: The drivers will get a least amount of cognitive workload on which of the – direction-based, count-based, and direction-and-count-based – designs?

5.4.1 Experiment Design

The independent measures of our study are displaying the roundabout information to the drivers with the help of the three vibrotactile designs. We compared three different vibrotactile designs – direction-based, count-based, and direction-and-count-based – to present the roundabout information. We used a within subject approach to conduct the experiment. In this approach, three different vibrotactile roundabout designs are evaluated with every participant in three different driving sessions.

5.4.2 Dependent Measures

Considering our research questions from Q1 to Q4, we selected the measures of performance, ranking, usability, and cognitive workload as dependent measures.

Performance: Performance is measured as a count of correctly interpreted signals by the participants on a given vibrotactile design. The participant was instructed to say aloud the meaning of every vibrotactile signal. We recorded the correct and wrong responses of the participants.

Ranking: At the end of all driving sessions, the participant was asked to rank all three vibrotactile designs according to his or her preferences. The participants provided the ratings of *most preferred*, *preferred*, and *least preferred* to each of the vibrotactile roundabout designs according to their preferences.

Usability: We used the System Usability Scale (SUS) questionnaire [Bro96] to measure the usability of all three vibrotactile designs. We provided the SUS questionnaire to the driver to collect data about a particular design at the end of each driving session.

Cognitive workload: The cognitive workload of the drivers was measured with the help of the NASA Task load Index (TLX)[HS88] questionnaire. We provided a 20 point scale questionnaire at the end of each driving session to get the drivers' cognitive workload measures on the particular design.

5.4.3 Participants

We evaluated a total of 12 participants, 4 female and 8 males in our experiment. The ages of the participants were on average 33 ($SD \pm 6$) years old. They have on the average of 6 ($SD \pm 7$) years of driving experience.

5.4.4 Apparatus

We used a Volkswagen Touran in our evaluation. The tactile belt is used to provide navigational aid to the driver in all sessions of the experiment. The participants ranked the vibrotactile designs according to their preferences at the end of the driving sessions.

Questionnaire: We collected the data with the help of the two questionnaires. The SUS questionnaire was used to measure the usability of the three designs. We measured the cognitive workload of the drivers by using NASA TLX questionnaire.

Interviews: We conducted interviews of the participants in the end of all three driving sessions to collect the qualitative measures regarding three vibrotactile roundabout designs.

Voice recordings: The open source software CamStudio¹ was used for capturing the laptop screen of the experimenter, and the voice of the participant. The participants were asked to announce the meaning of different roundabout signals every time they felt vibration. The vibrotactile signals pointed by the experimenter were captured from the laptop screen. Afterward, the participant's oral response on the category of distance was compared with the screen captures.

5.4.5 Procedure

The experiment was carried-out on a real urban mini, compact and single-lane roundabout intersection shown in Figure 5.11. We explained the whole experiment to the participant before leaving to the actual venue. We trained the participant on each of the three vibrotactile designs in a five minutes session.



Figure 5.11: Map of urban single-lane roundabout.

The participant wore the tactile belt before the driving sessions. Vibrotactile signals for displaying the roundabouts were controlled by the experimenter who was seated next to the driver. Three different vibrotactile roundabout designs were presented in the three different driving sessions. We provided the vibrotactile designs in a random sequence to each participant to balance any learning effects. Before starting the first driving session, we retrained the participant on the first

¹<http://camstudio.org/>

design. While driving, the participant was relying on the vibrotactile signals for the route guidance. After completion of the first route, we asked the participant to park the car and fill-out the questionnaires. The same procedure was repeated for the other two designs. After completing all the driving sessions, we conducted the interview with the participant. The participants provided their rating on all vibrotactile designs. On average, the whole experiment took about 80 minutes. Each of the participants drove on average 10 km.

5.5 Results

Statistical tests are applied to analyze the quantitative data of the dependent variables performance, ranking, usability, and cognitive workload. We gathered the response of the participants with the help of interviews and observation during evaluation for qualitative results. In the following, we present the dependent measures and qualitative results.

5.5.1 Performance

We applied Friedman's ANOVA to find the difference among the performance of the participants on the three vibrotactile roundabout designs. There is no difference in the performance of the participants on the vibrotactile roundabout designs, $Chi^2 = 4.0$, $p = 0.135$. Figure 5.12 presents the performance score on the three different vibrotactile designs. The participants performed 100% correct on the *direction-based* vibrotactile roundabout design. The participants did not make significant number of errors on the other two vibrotactile roundabout designs.

5.5.2 Ranking

The statistical results of pair-wise comparison of repeated measures test indicate that the *direction-based* design is ranked significantly better than the *count-based* design, $p < 0.05$. The *direction-based* design is ranked significantly better than the *direction-and-count-based* design, $p < 0.05$. Figure 5.13 shows that the *direction-based* vibrotactile design is the "most preferred" design. The *count-based* vibrotactile roundabout design is the "least preferred" design among all.

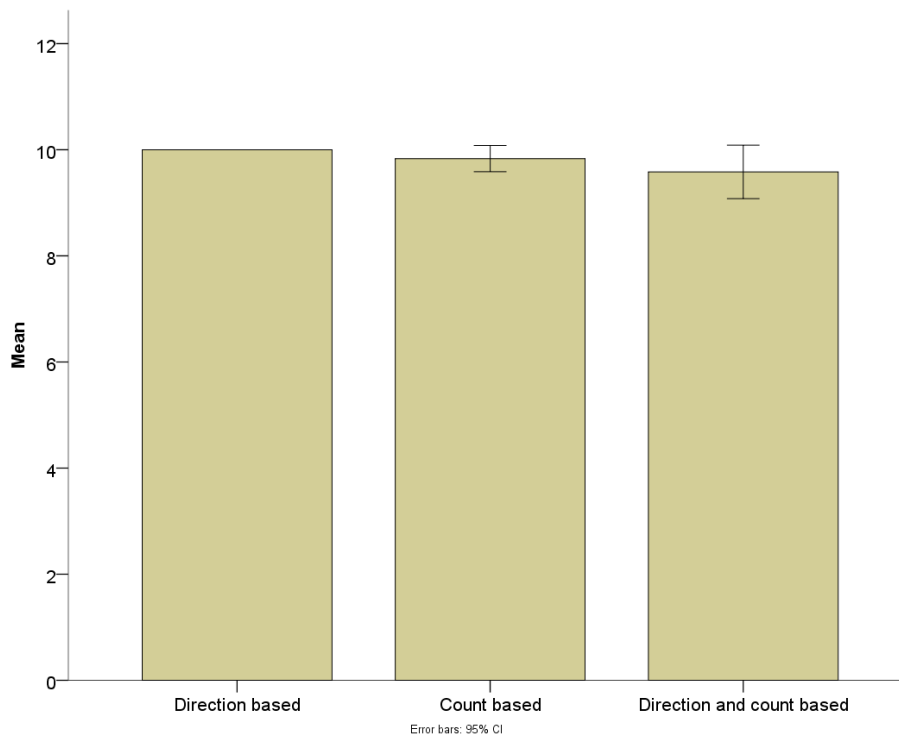

Figure 5.12: The participants' performance on the three vibrotactile roundabout designs.

5.5.3 Cognitive Workload

According to the repeated measure test, the cognitive workload of the driver on all the three vibrotactile designs is different, $Chi^2=7.251$, $p<0.05$. The workload of the drivers is different on *direction-based* design as compared to the *count-based* design, $p<0.05$. There is a difference in the workload of the drivers on the *direction-based* design and *direction-and-count-based* design, $p<0.05$. Figure 5.14 shows that the participants got less amount of cognitive workload while performing on the *direction-based* vibrotactile roundabout design as compared to the other two roundabout designs.

5.5.4 Usability

We statistically analyzed the data collected from System Usability Scale (SUS) questionnaire. According to the results, some factors of SUS are significantly

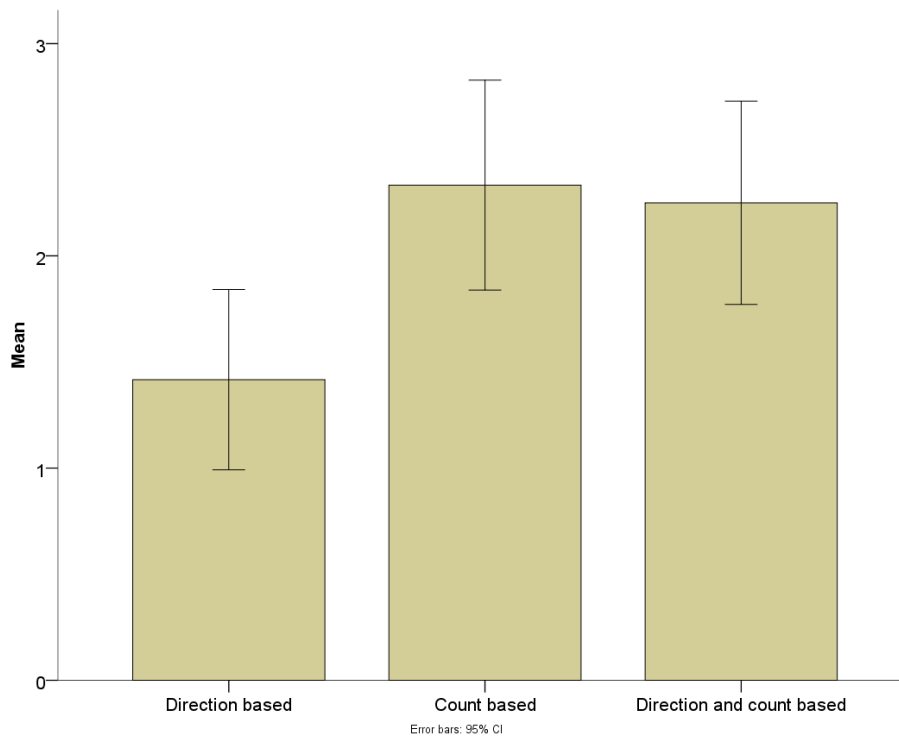

Figure 5.13: The participants ranking of the vibrotactile roundabout encodings.

different in the vibrotactile designs.

We applied Friedman test on SUS factor of function integration of the three vibrotactile designs for presenting the roundabout information. We found a significant difference in the integration of the vibrotactile designs for presenting the roundabout information, $p < 0.05$ $Chi^2 = 12.250$. This test, however, does not reveal a difference between the individual designs. We, therefore, analyzed the error bar graph in Figure 5.15 to see the difference between the individual designs. The graph indicates that the *direction-based* and *count-based* designs are well integrated than the *direction-and-count-based* design. A significant difference exists in the integration of the *count-based* design and the *direction-and-count-based* design, $p < 0.025$ $Z = -2.44$. Similarly, the integration of the *direction-based* and *direction-and-count-based* designs are significantly different, $p < 0.025$ $Z = -2.271$.

Friedman test of system in-consistency reveals a significant difference among three vibrotactile designs of presenting the roundabouts, $p < 0.05$ $Chi^2 = 8.273$. The error bar graph in Figure 5.16 presents that the *direction-and-count-based* design

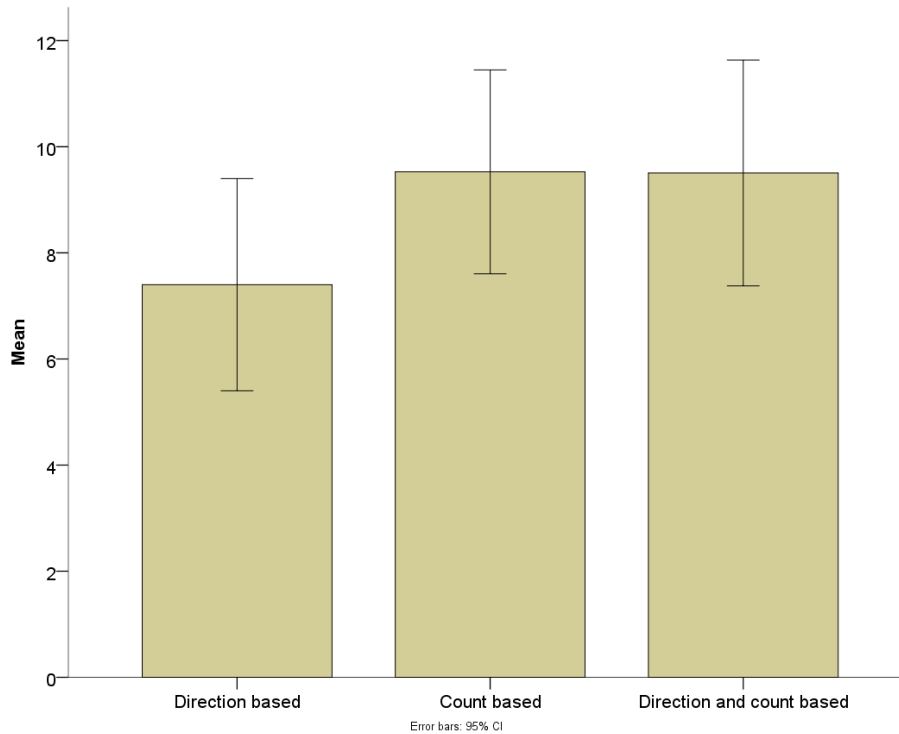

Figure 5.14: The participants' cognitive workload measure while performing on different vibrotactile roundabout designs.

is more inconsistent than the other two designs. The Wilcoxon test showed a significant difference between *direction-and-count-based* design and *direction-based* design, $p < 0.025$ $Z = -2.220$.

There is a significant difference in cumbersome to use in the three vibrotactile designs for presenting the roundabout, $p < 0.05$ $Chi^2 = 10.211$. The Figure 5.17 presents that the *direction-and-count-based* design is more cumbersome to use than other two vibrotactile designs for presenting the roundabout information. According to Wilcoxon test *direction-and-count-based* design is different than *direction-based* design, $p < 0.025$ $Z = -2.271$.

The Figure 5.18 shows that the participants feel more confident on *direction-based* design as compared to the other two designs. We found a significant difference in the confidence between *count-based* design and *direction-based* design, $p < 0.025$ $Z = -2.333$.

According to Friedman test, we did not find any significant difference on

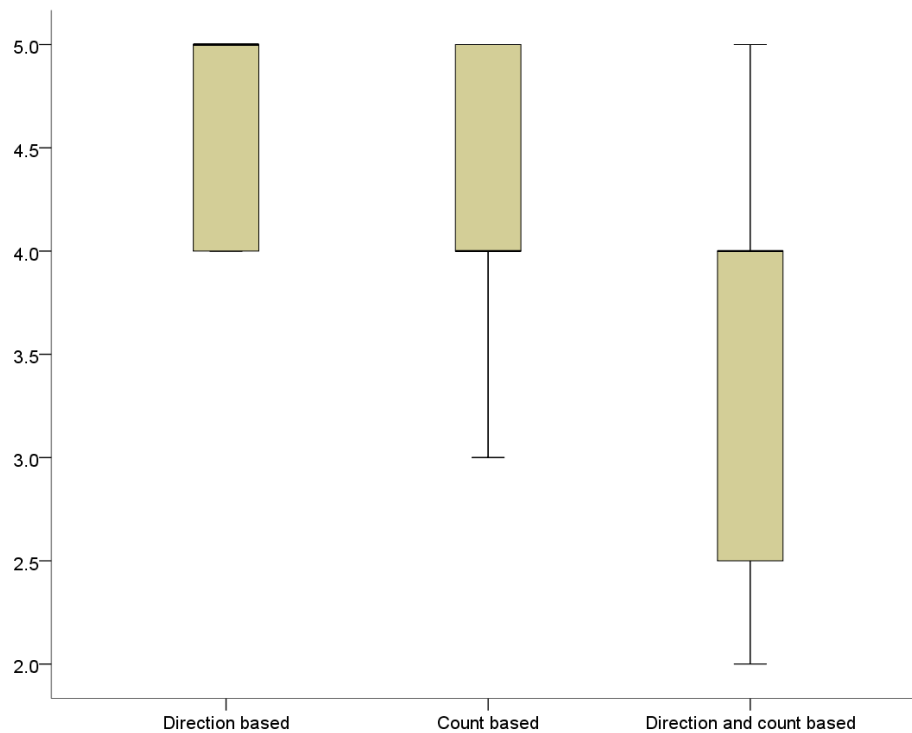

Figure 5.15: *Direction-and-count-based* design is not well integrated as compared to other two designs.

factors, such as frequency of use $p=0.131$, complexity $p=0.104$, technical support= 0.184 , and learn to use $p=0.335$ in all the three vibrotactile designs for presenting the roundabout intersection. The Figure 5.19 shows a bar graph for comparison between various usability factors of the three vibrotactile designs of presenting the roundabout.

5.5.5 Qualitative Results

We have conducted post-experiment interviews. In this section, we will present the responses of the drivers on interview questions, and our observations during the experiments.

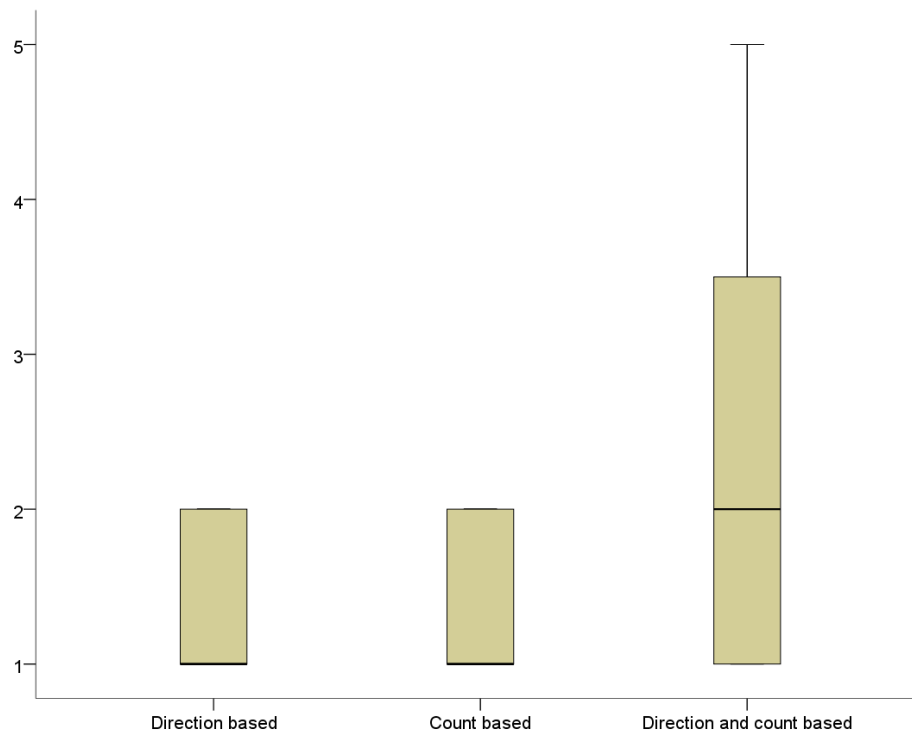

Figure 5.16: *Direction-and-count-based* design is more inconsistent as compared to other two designs.

Performance and Impression about Vibrotactile Designs

All participants were sure that they successfully performed on the *direction-based* design. 1 participant was unsure about his performance on the *count-based* design. 11 participants were sure as to they successfully performed on the *count-based* design. 3 participants were unsure about their success on the *direction-and-count-based* design. "The *direction-based* design was best for me because I did not need to count signals, that do not cause more cognitive workload." "I have a problem of counting in the *count-based* design." "*Direction-and-count-based* design was more complex for me." "I am more comfortable with the *direction-and-count-based* design; it was providing the maximum amount of information. In more complicated situations, it is easier to perceive in the *direction-and-count-based* design." "*Direction-based* design is easier to use, I do not need to think so much." "*Direction-and-count-based* design was confusing for me because, for different

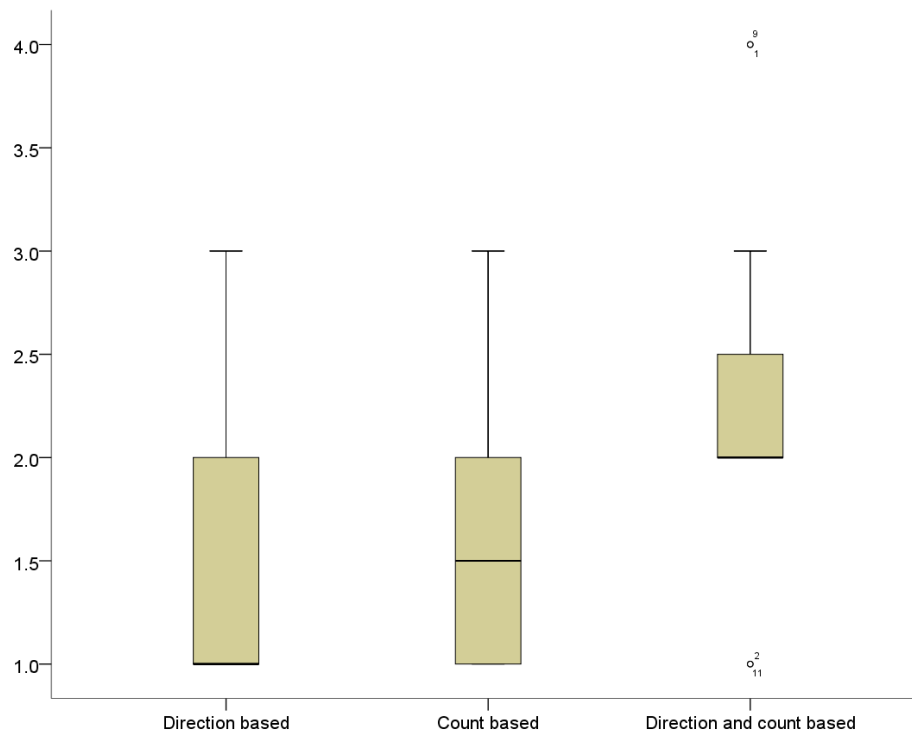

Figure 5.17: *Direction-and-count-based* design is more cumbersome to use as compared to other two designs.

types of intersections, vibrotactile signals are perceived on different body locations."

Vibrotactile Information Inside the Roundabout

9 participants were agreed to have *exit-now* information inside the roundabout. "It is good to have vibrotactile signals indicating *exit-now* inside the roundabout, because it has confirmed that I have to exit now." "If there are more than three exits, then vibrotactile indication inside the roundabout is really helpful." "The vibrotactile information inside the roundabout is helpful if the car missed the correct exit. The car can stay inside the roundabout until vibrotactile signal will indicate "to take exit now"." 3 participants told that they did not require the vibrotactile signals inside the roundabout. "I do not need vibrotactile signals when there are only three exits because I can remember the count of the exit. However, if there

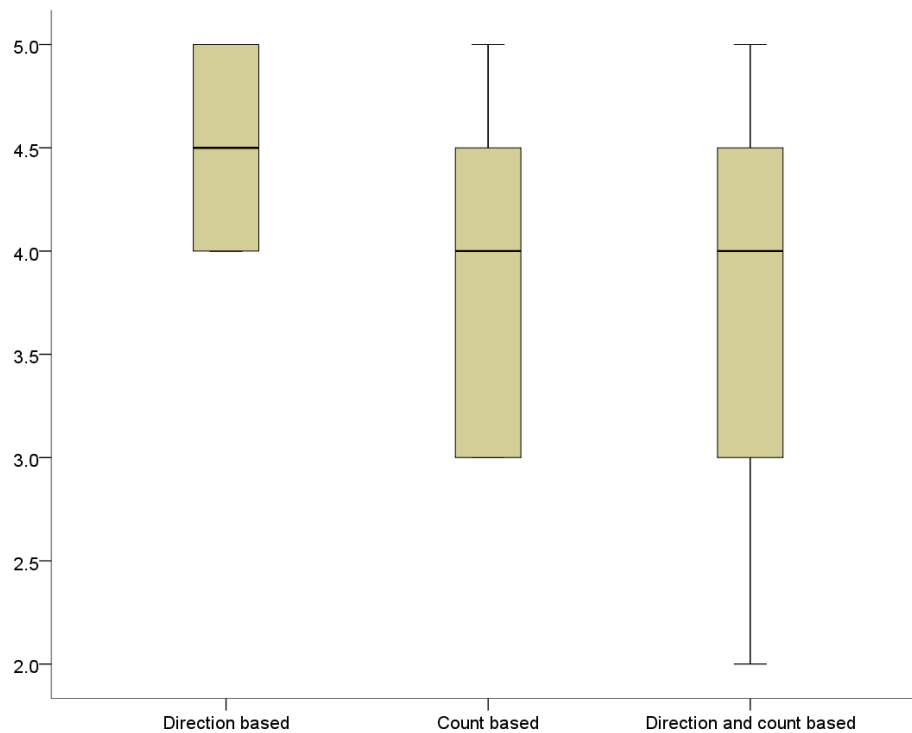

Figure 5.18: The *direction-based* design is more confident to use than other two designs.

are more than 3 exits, I need a vibrotactile signal inside the roundabout." "It will be nicer to have vibrotactile signals as a reminder in case of a big roundabout."

Body Location

All participants like the vibrotactile signals for presenting the roundabout information. The body location was suitable for 11 participants in *direction-based* design. The vibration on front of the body was annoying for 1 participant in *count-based* design.

Distraction

9 participants told that the vibrotactile signals were not distracting for them. "It was less distracting than a commercial car navigation system." The vibrotactile signals were more distracting for 3 participants. "Yes, it was distracting, because

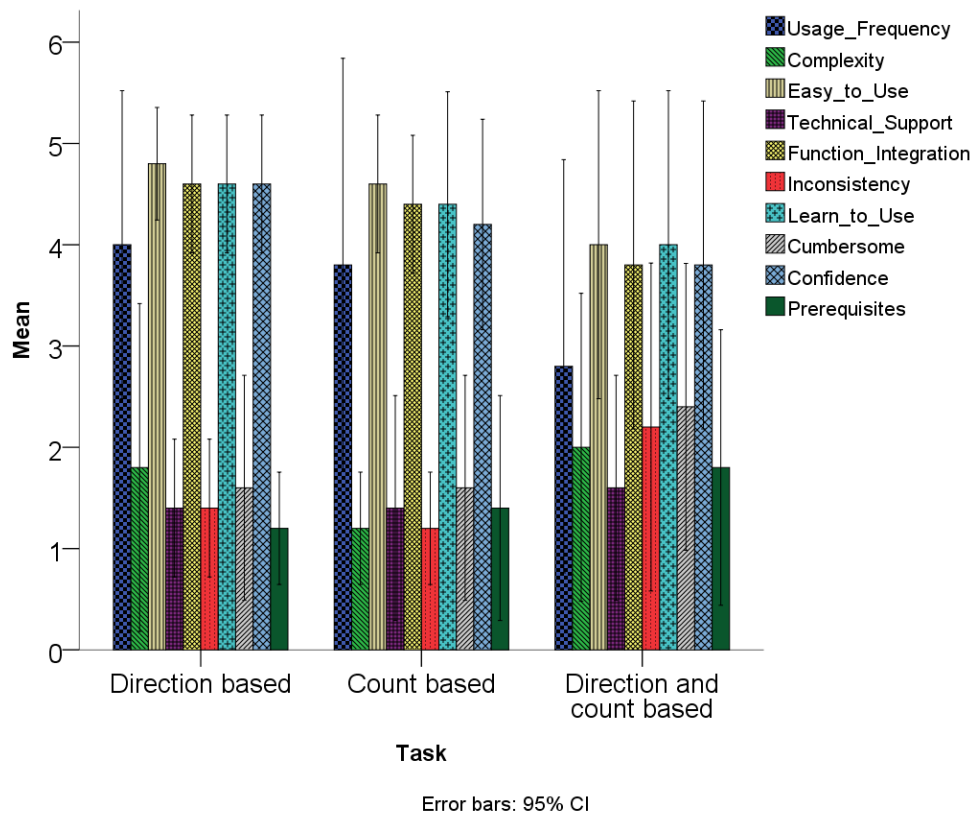

Figure 5.19: Usability measures of *direction-based*, *count-based*, and *direction-and-count-based* designs.

you always think that signals are coming after getting roundabout indication." "The vibrotactile signal which shows the information about intended exit was more distracting for me." "The vibrotactile roundabout signal was not distracting before entering the roundabout, but more irritating after entering the roundabout."

Visual and Auditory support

4 out of 12 participants required the support of an auditory interface with a tactile display. 3 out of 12 participants required support of a visual display. "No, I do not need the support of any visual or auditory interface. It would be very distracting. We are so trained on visual interfaces so, it will always attract our attention."

5.6 Discussion

The tactile interface is certainly helpful on intersections like the roundabout for presenting navigation information. Our study shows that the participants appreciated the use of a tactile display on intersections like the roundabouts. The results indicate that the *direction-and-count-based* design has proved to be an unsuccessful design with respect to performance, cognitive workload, and usability. The participants comparatively preferred the *direction-based* design with regard to ranking, cognitive workload, and usability on the given scenario. We, however, did not find a huge difference between the *direction-based* design, and the *count-based* design on dependent measures. In the following, we discuss our research questions (see Section 5.4) concerning the experiment's results.

Q1: Can drivers successfully perceive and interpret the vibrotactile signals that display the roundabout intersection?

We observed from the results that participants performed 100% well on *direction-based* design. The performance rate of participants was above 90% on the other two vibrotactile designs for presenting the roundabouts. Similarly, the qualitative results showed that all participants were sure that they performed well on the *direction-based* design. Furthermore, a big ratio of the participants was also sure about their successful performance on the *count-based* design, and the *direction-and-count-based* design. The results regarding the support of visual or auditory interfaces showed that most of the participants did not require the support of visual and auditory interfaces with the tactile belt. Most of the participants believed that the tactile display was not distracting them from the driving task. The body location for presenting the vibrotactile signals was suitable for the participants in all vibrotactile roundabout designs. Both quantitative and qualitative results, therefore, indicate that the participants were successful to perceive and interpret, and were confident on, all the three vibrotactile designs for displaying the roundabout intersections.

Q2: Which of the designs – direction-based, count-based, and direction-and-count-based – is most suitable for presenting the information on roundabout intersection?

The qualitative results showed no significant difference in the performance of the participants on all the three vibrotactile roundabout designs. According to the rating scores, mostly participants preferred the *direction-based* design for roundabout information. The observations indicated that the *direction-based* design was easier to use for the participants for perceiving the roundabouts information during the experiment. It was observed in the *count-based* design that the count of

a number of pulses was discouraged by some of the participants. Similarly, the participants felt that the *direction-and-count-based* was comparatively complex in the given scenario. So, the qualitative results regarding the suitability of vibrotactile roundabout design strengthened the validity of the ranking of the participants for the different vibrotactile roundabout designs. According to the qualitative and quantitative results, the *direction-based* design might be a suitable design for presenting roundabout information in the given scenario.

Q3: Among – direction-based, count-based, and direction-and-count-based – designs, which is most usable for presenting the information on roundabout intersection?

The results of the SUS questionnaire for usability showed that the *direction-based* design was more well integrated than the *direction-and-count-based* design. The *direction-and-count-based* design is less integrated than the *count-based* design. It shows that the participants did not like the integration of the *direction-and-count-based* design. We found that the *direction-and-count-based* design was significantly more inconsistent than the *direction-based* design. Similarly, the *direction-and-count-based* design is more cumbersome than the direction-based design. The results indicate that the drivers were more confident on the *direction-based* design than the count-based design. According to the quantitative results, the *direction-and-count-based* design was the least usable vibrotactile design among all. A reason could be that it was the most complex design among all the three vibrotactile designs. The previous studies [AHB10] indicate that the drivers prefer to have a simple design for perceiving the vibrotactile information with tactile displays in the cars. The usability results do not show a huge significant difference between the *direction-based* design and count-based design. The qualitative observations, however, declare that the participant found it complex and demanding to count a number of pulses. So, we propose the *direction-based* design as a usable design for urban mini, compact, and single-lane roundabouts.

Q4: The drivers will get a least amount of cognitive workload on which of the – direction-based, count-based, and direction-and-count-based — designs?

The results show that the driver imposed the least cognitive workload by using the *direction-based* design. The reason could be that the driver is required to count a number of pulses and remember them in *count-based* design. The *direction-and-count-based* design is proved to be complex for presenting roundabout information as compared to other two designs. Therefore, the results indicate the *direction-based* design is most favorable design for displaying roundabout.

We observed that it is context dependent to present the roundabout information using *direction-based* design and *count-based* design. In our scenario the

most successful design was the *direction-based* design, since the center of the roundabout was not very high and all exits were easily visible for the drivers. Qualitative results regarding the final vibrotactile signal inside the roundabout indicate that it is quite helpful for indicating the intended exit in the given scenario or other complex scenarios.

The results of our study are quite helpful to explore the vibrotactile designs for presenting the roundabouts. Though, our study contained 12 participants. It is expected the results with a huge number of participants might lead to similar conclusions. We carried out this study on urban mini, compact and single-lane roundabouts, which will be quite helpful for further vibrotactile designs for more complex roundabout types. We conducted the evaluation on real urban roundabouts so the results are valid for a real urban environment.

5.7 Summary

Previous studies [AHB10, HVEK09] showed that tactile displays could successfully be used to display the spatial information to the drivers. In this Chapter, first we investigated different methods of design for the roundabout information with vibrotactile signals. Second, we compared three vibrotactile roundabout designs on the basis of the participants' performance, ranking, usability, and cognitive workload. We conducted the experiment on single-lane roundabouts in an urban scenario.

The study provides a proof-of-concept that the tactile interfaces can successfully be used to present navigation information to the drivers about intersections like roundabouts without the support of visual and auditory interfaces. According to the quantitative measures of ranking, usability and cognitive workload, and qualitative results, the *direction-based* design is the most successful among all the three vibrotactile roundabout designs. *Direction-and-count-based* design is the most unsuccessful design according to quantitative and qualitative results. The results of this study will certainly contribute to further investigation of vibrotactile designs of the other roundabout types.

The discovery of vibrotactile signals for presenting roundabout information will contribute in the development of tactile-based car navigation system. The roundabout is popular intersections with regard to safety aspects, so vibrotactile presentation of roundabout information is necessary in the car navigation systems.

Chapter 6

Evaluation of Car Navigation Systems in High Workload

The modern cars have a number of information systems for supporting a driver in driving process. One problem of modern in-vehicle systems is, a driver can get too much workload with the excessive amount of information coming via limited available channels. A car navigation system is one type of the in-vehicle systems. So, this problem can be overcome by using an alternative channel of navigation according to MRT. In the previous chapters of this thesis, we exploited the tactile display as an alternative channel for presenting the navigation instructions in the cars. The performance of the drivers can be evaluated on secondary tasks while getting information via this channel, and that might help determine increase or decrease in their performance. Our studies deal with the evaluation of navigation help by the conventional and alternative channels in high workload environment. We would also investigate whether the usage of the alternative channel for the navigational aid imposes the additional workload on the drivers. This chapter presents the evaluation and comparison of the car navigation systems, such as (1) tactile-based navigation system, and (2) conventional navigation system.

6.1 Performance Evaluation of System

In the past few decades, the automotive industry has developed cars to provide functionality beyond the basic task of driving. The latest cars are heavily equipped with a number of infotainment systems, such as navigation, radio/CD, location-based services, PDAs, and music systems. Mainly, these systems provide visual

and audio interfaces for communication with a driver. According to MRT of task interference [HW03], the channels of communication are limited as compared with the number of systems. This may lead to increased demand on the cognition, perception, and response of a driver on a given system. This growth in demand imposes a huge amount of information on visual and auditory resources. The presence of infotainment systems increases the risk of diverting the visual and auditory attention of the drivers. These tasks might interfere with each other while driving. Drivers are spending one third of their time looking inside the vehicles [SG08]. This means a driver has to process a lot of information. A driver can get an additional workload while using this system. He/she can also miss the appropriate turn; this may result in additional driving effort. Additionally, a driver might not be able to correctly perform the other in-vehicle secondary tasks. A driver can, thus get confused in these situations which reduces driving safety.

The tactile interfaces can be an alternative means of providing route guidance to a driver. The previous chapters provide the proof-of-the-concept that the tactile-base navigation aid is successful in bringing a driver to destination(s). The one reason of proposing the tactile display for route guidance of a driver is to support him/her in the other visual and auditory tasks during the driving. Thus, it is expected that the tactile display contributes in increasing the performance of the drivers on other visual and auditory tasks. In order to validate this, evaluation of the performance of the drivers is needed in the high workload visual and acoustic conditions when they navigate with the help of the tactile-based navigation system. This can assure the importance of such interface in the car navigation systems. The drivers are required to deal with the alternative display along with the existing visual and auditory display. This will help in evaluating the driving performance of the driver in the circumstances when the information comes from all available channels. It is a demanding question that whether the tactile displays will replace or accumulate in the existing car navigation systems. In the following, the experimental studies attempt to unfold the answers of these questions.

Structure of this chapter

Figure 6.1 shows the overview of Chapter 6. This chapter presents the two major experiments. The first experiment in Section 6.2 deals with the comparison of the tactile display with the conventional car navigation system. In this experiment, acoustic workload is introduced to a driver during the driving sessions. The second experiment in Section 6.3 presents the users study in the real scenario comparing the drivers' performance on the tactile display, the car navigation system, and the combine (tactile & navigation system) in visual and auditory workload. We close this chapter with our conclusion and summary in Section 6.4. The parts

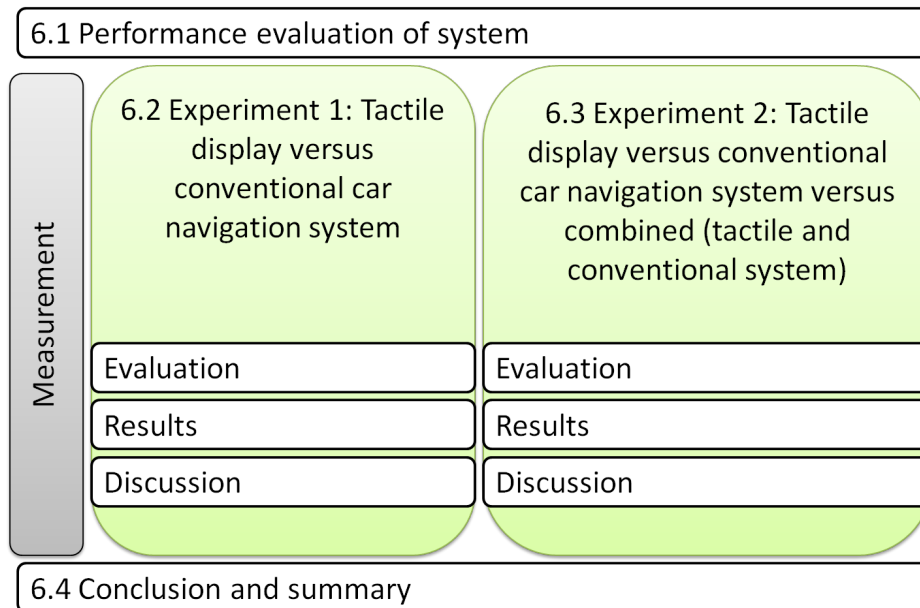

Figure 6.1: Overview of Chapter 6.

of this chapters are published in [AB10].

6.2 Experiment 1: Tactile Display Versus Conventional Car Navigation System

The modern cars are equipped with many systems, such as driver assistance systems and infotainment systems. These systems provide a number of functionalities, such as warning information and entertainment to a car driver. These systems are available with one or more user interfaces. A driver needs some expertise in order to deal with the available interfaces. When a driver uses a car navigation system, he/she also deals with the different interfaces for input and output of information. In these situations, the driver might make mistakes on these systems; the interfaces may distract the driver from the main driving task, and might increase the cognitive workload of a driver. We conducted a users study in order to see an effect of the tactile display on performance, distraction, and cognitive workload of the drivers. We compared the tactile display with the conventional car navigation system in our users study.

The evaluation was done in a real urban road environment. We assigned an additional secondary task of Paced Auditory Serial Addition Task (PASAT) [BCL⁺06, BW09] to the drivers along with the task for following the conventional navigation system or the tactile display. The details of PASAT are provided in the Section 6.2.1. The purpose of the additional task was to create a high auditory load on the drivers.

van Erp and van Veen [EV04] discovered that the tactile navigation displays reduce the workload of the drivers as compared to visual displays in a high load environment. Nevertheless, it is missing in previous findings, whether the tactile displays will help reduce the cognitive workload, increase the performance, and reduce distraction of the driver as compared to the conventional car navigation systems in high load situations. Thus, we aim to answer the following research questions in our evaluation:

- Q1:** How does the presentation of the directions and distances information with a tactile display will affect the cognitive workload of the driver in a high demanding condition?
- Q2:** How will the participant perform on secondary task while following the commands of a conventional car navigation system as compared to a tactile display?
- Q3:** Which of the systems between the tactile display and conventional car navigation system will more distract the driver from a secondary task?

6.2.1 Experiment Design

In this experiment, we compared the presentation of the turn-by-turn direction and distance information with a conventional car navigation system and the tactile display. We explained *the one vibrator design* in Section 4.3 of Chapter 4. The *one vibrator design* was used to present information with the tactile display. We compared two experimental conditions: (1) conventional navigation system, and (2) the tactile display.

The participants had to perform the PASAT [BCL⁺06, BW09] test in the three conditions i.e. driving a car, driving, and following a route according to the conventional car navigation system, and driving *and* following a route according to the tactile display. PASAT is a frequently used secondary task in the context of driving [BW09]. PASAT is a cognitive task to measure the working memory, speed of information processing, and sustained and divided attention [BCL⁺06].

PASAT was originally proposed to measure change in the performance of patient during recovery of closed-head injuries [BCL⁺06]. Balzano et al. [BCL⁺06] instructed a group of multiple sclerosis patients and a control group of healthy people to perform a counting task: A series of pairs of numbers had to be added at a rate of 3 and 2 seconds respectively. The results showed that both groups of the participants performed significantly better on the 3 seconds task as compared to the 2 seconds task. No significant difference was found between groups on late responses to the task. The heart rate and blood pressure are the primary measures of human workload and stress level [BJS09]. In our study, we need to make a highly workload environment by introducing a demanding secondary task. Mathias et al. [MSH04] discovered that the heart rate and blood pressure were significantly high during testing periods of PASAT. So, PASAT can be qualified as a non-visual secondary task for further evaluations. Our dependent measures are cognitive workload, distraction level, and performance. In the following, we describe the independent measures of our user study.

Cognitive workload: We measured the cognitive workload of the drivers by measuring their performance on the secondary task of PASAT while driving and performing the navigation task. X is the performance of the driver on PASAT in simple driving condition. The symbol Y is used to present the performance of the driver on the task of PASAT in navigation with the conventional car navigation system condition. The performance of the driver on PASAT in condition of the tactile display is presented by Z . The cognitive workload of the drivers can be calculated for the conventional car navigation system, and the tactile display by the following algorithm:

```

if  $(X - Y) == 0$  or  $(X - Z) == 0$  then
    No change in cognitive workload
end if
if  $(X - Y) < 0$  then
    Car navigation system reduces cognitive workload
else
    if  $(X - Y) > 0$  then
        Car navigation system increases cognitive workload
    end if
end if
if  $(X - Z) < 0$  then
    Tactile display reduces cognitive workload
else

```

```

if  $(X - Z) > 0$  then
    Tactile display increases cognitive workload
end if
end if

```

The results of the drivers' cognitive workload while using the car navigation system and the tactile display can be interpreted with the help of following algorithm:

```

if  $(X - Y) > (X - Z)$  then
    Car navigation system imposed more cognitive workload
end if
if  $(X - Y) < (X - Z)$  then
    Tactile display imposed more cognitive workload
end if
if  $(X - Y) == (X - Z)$  then
    Equal amount of cognitive workload
end if

```

A negative value means a reduction in cognitive workload. Zero indicates no change, and a positive value an increase in the cognitive workload.

Performance: We measured the performance by counting the number of the wrong responses of the drivers in PASAT. Furthermore, we compared the disorientation of the drivers using the tactile display and the conventional car navigation systems. The disorientation occurs when the driver missed the intended turn.

Distraction: The distraction of the driver was measured by comparing the count of numbers that the participants were unable to answer on PASAT. We compared the tactile display with the conventional car navigation system with respect to level of distraction.

6.2.2 Participants and Apparatus

Overall, 10 participants of average age 32.8 year ($SD \pm 5.90$) took part in the evaluation. The sample contained 5 male and 5 female participants. The participants were driving license holders for an average of 12.9 years ($SD \pm 7.40$). The sample contained 1 beginner, 7 experienced, and 2 expert users of car navigation systems. We conducted pilot sessions in a dense urban traffic condition, and tested 1 male and 1 female participants before the actual evaluations. The participants reported that it was safe to perform the secondary task while driving on the road in both conditions.

We used a Volkswagen Touran car in our evaluation. A built-in conventional navigation system – RNS 310, Navigation Radio System – was used for navigation purposes¹ (see Figure 6.2). The conventional car navigation system contains a clear 5 inch color screen displaying a map of the route. A speech based interface guides the participants to the destination via speech interface. Our tactile belt was used as the tactile display. The controller of the tactile belt was connected to the laptop of the experimenter. We used PASAT as an additional secondary task to perform during the experiment. During the experiments, oral feedback of the participants was recorded. At the end of all sessions, we asked a few interview questions regarding the participants’ impressions on the tactile display, and engagement with the environment.



Figure 6.2: Car navigation system RNS-310.

6.2.3 Procedure

The experimenter was seated next to the driver. The tactile feedback is triggered on each intersection to present direction and distance information to the participant. For longer streets, the four categories of distances (see Section 4.4.2) were presented to the participants. For smaller streets, three or two categories

¹<http://www.volkswagen.co.uk/new/touran/explore/experience/comfort/rns-310-navigation/radio-system>

of distance were presented according to the length of road. The participants were trained on the one vibrator design. We also provided training of the secondary task PASAT to the participants before the experiments. In PASAT, the participants were required to count numbers and tell the sum aloud while driving without using any navigation system, using the conventional car navigation system, and using the tactile display.

In previous studies [BCL⁺06], the evaluations have been done on 2 seconds (sec) and 3 sec trails of PASAT. The 2 sec and 3 sec trails of PASAT as secondary tasks were long enough to collect data on the road conditions. In each experimental condition, first we played a sequence of numbers with the pace of 3 sec followed by 2 sec. Four different sequences of numbers were presented to the participants in the whole experiment. In PASAT, the driver hears a male voice saying sequence of 50 numbers from 1-9. The driver adds the first number to the second number, and tells the sum aloud. Then the participant is required to add this sum to the next number and so on.

First, the driver needed to count the sequence of the number only in the driving condition. After completing the first task, the drivers had to reach another destination by following commands of the car navigation system, and performed secondary task PASAT. Next, we provided the training session to the participants with the tactile display while driving. In the last session, the driver had to count the numbers of the provided sequences of PASAT during navigating with the tactile display. Figure 6.3 presents all driving sessions i.e. driving only, the car navigation system, and the tactile display. The participant started from point "A" and ended on point "B" on driving only condition and performing on first sequence of PASAT. From the point "B" to the point "C", the participant drove using the car navigation system and performing on second sequence of PASAT. On the route showed from point "C" to point "D", the participant drove on the condition of the tactile display only, and performed on third sequence of PASAT. The whole experiment lasted about 1.5 hours included pauses for data storage, and interview before the next session. On average, each participant drove a distance of 14 km.

6.2.4 Results

We analyzed the audio recordings of the participants' responses on PASAT. The correct response, wrong response, and missed response are considered during data analysis. We calculated descriptive statistic for every dependent variable. The sophisticated statistical analysis could not be applied because of the low number of participants.



Figure 6.3: Map showing the route taken by the drivers for experiment.

Cognitive Workload

Figure 6.4 shows the comparison of cognitive workload of the drivers using the conventional car navigation system and the tactile display. The results are calculated and interpreted according to the algorithm given in Section 6.2.1. The participants 2 and 6 have a reduced cognitive workload on the conventional car navigation system while performing the secondary task PASAT-3 sec. Participant 1 reduced the cognitive workload on the tactile display while performing on PASAT-2 sec. Participants 8 and 9 have no change in cognitive workload on the tactile display while performing on PASAT-3 sec.

Participants 1, 8, and 9 reduced the cognitive workload on the tactile display as compared to the conventional navigation system while performing on PASAT-3 sec. Participants 1, 4, 8, and 10 showed a reduced cognitive workload load on the tactile display as compared to the conventional car navigation system while performing PASAT-2 sec. There was no significant difference in the cognitive workload of the driver using the tactile display and conventional car navigation system, and performing PASAT-3 sec, $p= 0.357$. Similarly, there was no significant difference observed in cognitive workload of the driver using the tactile display and the conventional car navigation system at PASAT-2 sec, $p=0.444$.

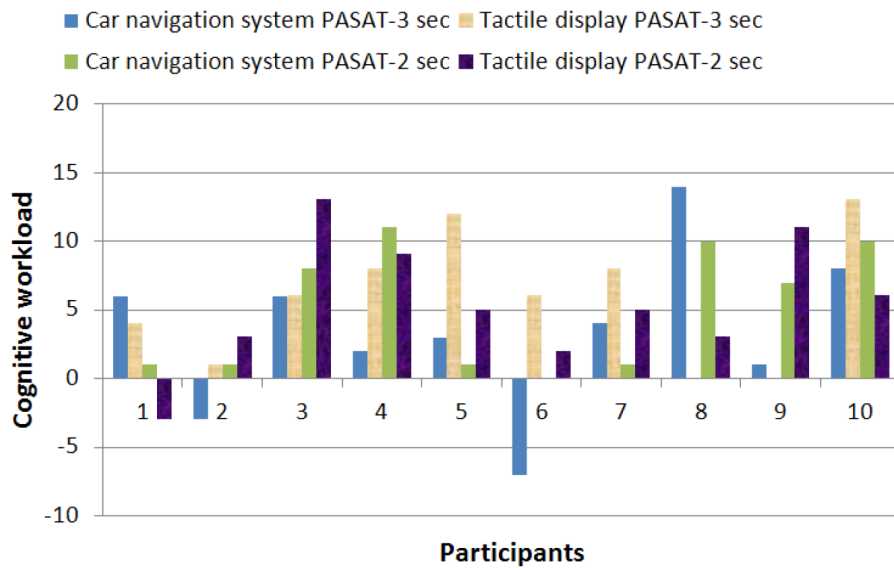

Figure 6.4: Measurement of cognitive workload of the participants.

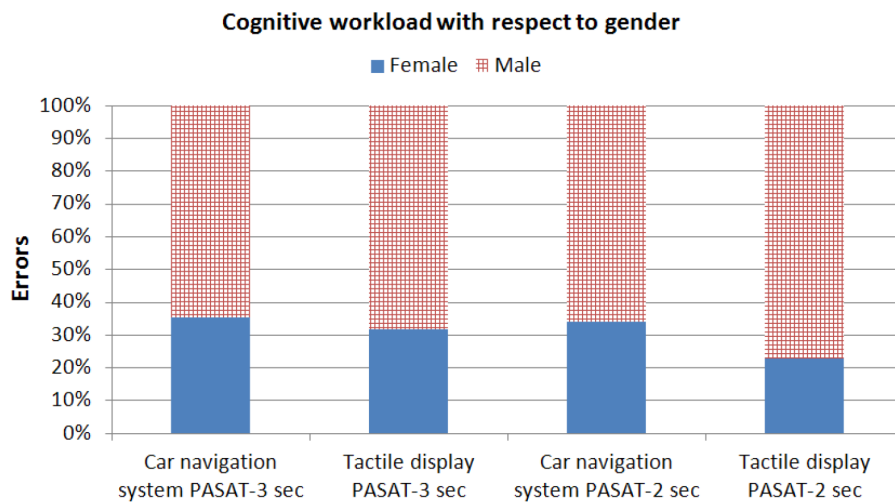

Figure 6.5: Male and female difference of cognitive workload.

Gender Differences

Figure 6.5 showed a comparison of the errors made by male and female participants in both conditions of the tactile displays and the car navigation system in

highly demanding environment. The male participants made more errors than the females participants on the conventional car navigation system (PASAT-3 sec 64% , PASAT-2 sec 66%). Similarly, the male participants made more number of errors than the females participants on the tactile display (PASAT-3 sec 69%, PASAT-2 sec 79%).

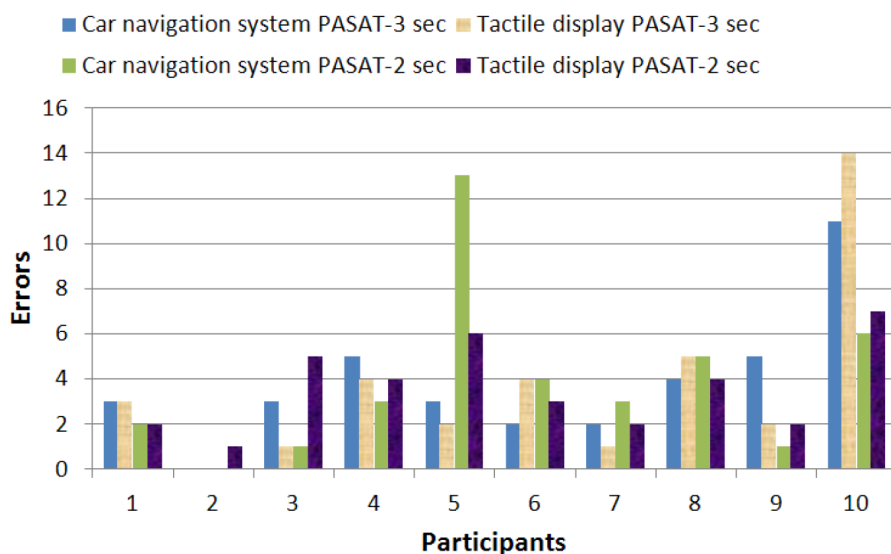

Figure 6.6: Comparison of performance of the participants on PASAT-3 sec and PASAT-2 sec on the conditions of car navigation system, and the tactile display.

Performance

Figure 6.6 presents a comparison of the performance of participants on the secondary task while driving with the conditions of the tactile display and the conventional car navigation system. On PASAT-3 sec and PASAT-2 sec, the participants made 36 errors using the tactile display and 38 using the conventional car navigation system. On PASAT-3 sec and PASAT-2 sec the participants made 36 errors using the tactile display and 38 using the conventional car navigation system. Participants 1 and 2 made an equal number of errors on PASAT-3 sec on the conditions of the tactile display and the car navigation system. Participants 3, 4, 5, 7, and 9 made less number of errors on PASAT- 3 sec with the tactile display as compared to the conventional car navigation system. Participants 5, 6, 7, and 8

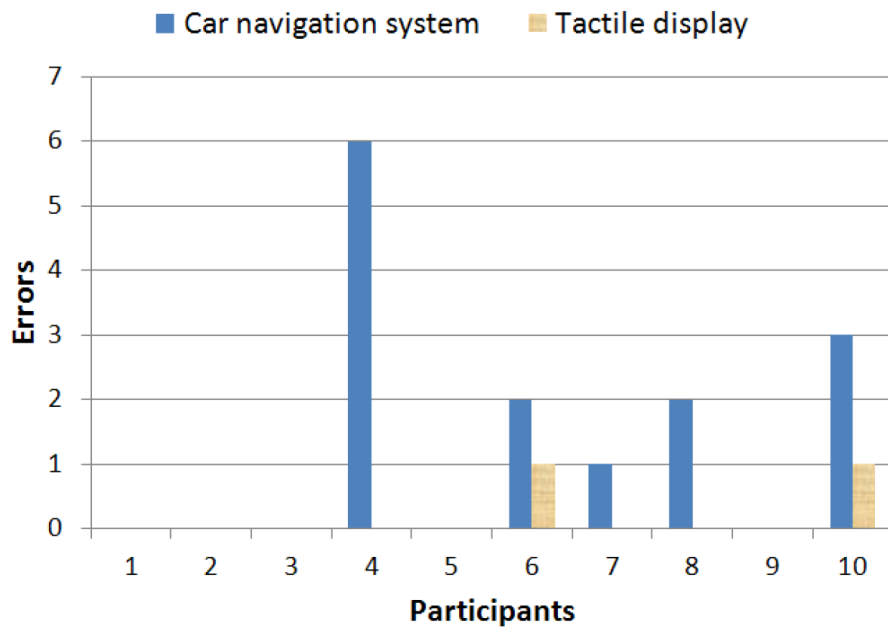

Figure 6.7: Comparison of drivers' orientation performance on conventional car navigation system and the tactile display.

made less number of errors on PASAT- 2 sec with the tactile display as compared to the conventional car navigation system.

Figure 6.7 presents the number of errors made by the participants while following the navigational commands of the tactile display and the conventional car navigation system. The results show that the participants were disoriented 14 times using the conventional car navigation system. The participants were, however, disoriented only 2 times while using the tactile display. There was no significant difference in the number of errors made by the participants on PASAT-3 sec using the tactile display and the conventional car navigation system, $p=0.722$. Similarly, there was no significant difference in the errors of the participants on PASAT-2 sec while performing on the tactile display and the conventional car navigation system $p=0.852$.

Distraction

Figure 6.8 presents a comparison of the level of distraction using the tactile display and the conventional car navigation system. Participants 1, 5, 7, 8, and 10 were less distracted on PASAT-3 sec with the tactile display as compared to the conventional car navigation system. Participants 1, 6, 7, and 10 were less distracted on PASAT-2 sec with the tactile display as compared to the conventional car navigation system. Participants 4 and 5 were equally distracted on PASAT-2 sec using the tactile display and the conventional car navigation system. Participants 5 and 3 did not get distracted on PASAT-3 sec with the tactile display condition. Furthermore, the participants were unable to count the questions in the secondary task in a total of 113 times and 111 times by using the conventional car navigation system, and the tactile display respectively. There was no significant difference in the responses missed by the participants on PASAT-3 sec using the tactile display and the car navigation system, $p=0.443$. Similarly, there was no significant difference in the missed responses of participants on PASAT-2 sec using the tactile display and the conventional car navigation system, $p=0.944$.

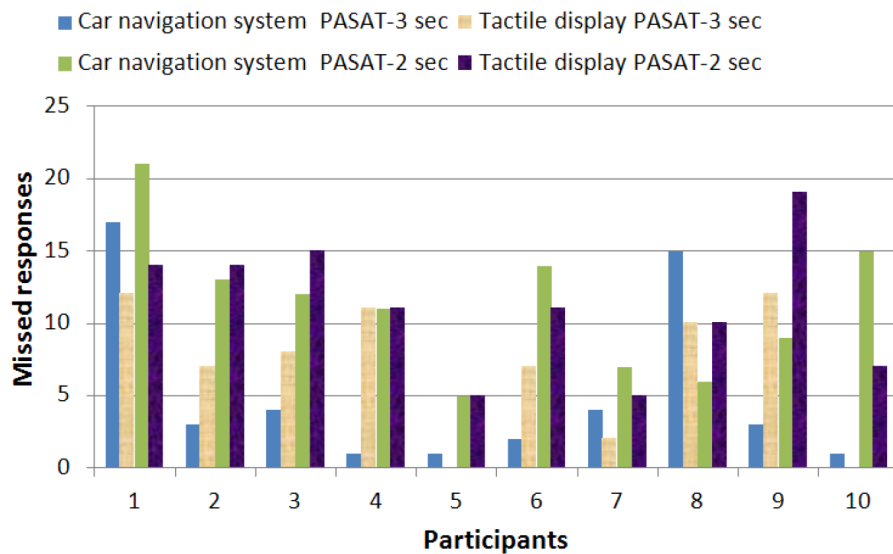

Figure 6.8: Comparison of distraction of the participants on PASAT-3 sec, and PASAT-2 sec on the conditions of car navigation system, and the tactile display.

Qualitative Results

The qualitative results report the responses of the participants on interview questions and observations. We asked questions regarding their performance in experiment, and engagement with the environment –streets names, signal crossings, bricked roads – while driving with the tactile display.

The interpretation of the tactons that present the direction was very easy for 6 participants. 4 participants reported that they faced problems in identifying the "front-right" and "front-left" directions. 6 participants did not report any problems in distinguishing the different distances. "The vibrotactile distance encoding works well but it is demanding." "Sometimes I was unable to remember different counting of pulses, but it works fine when there were 2 pulses or 1 pulse." One participant had problems in differentiating between "near" and "far" and one participant was unable to differentiate between "very-far" and "far." Another participant was unable to remember the counting of vibrotactile pulses while counting the numbers on PASAT.

The tactile belt did not cause any distraction according to the 8 participants. The tactile belt was a bit distracting according to 2 participants. 7 participants reported that they did not remember the names of the streets but one of them was able to remember the names of 2 streets. 9 participants remembered that they crossed a bricked road while driving with the tactile display. All the participants remembered that they passed by crossings with signals approximately 4-15 times.

6.2.5 Discussion and Conclusion

The results show that the tactile display helps drivers successfully navigate in an urban environment. The results did not show any significant differences in the cognitive workload of the drivers on the tactile display and the conventional car navigation system condition. The participants were able to perform equally well on PASAT by using the tactile display and the conventional car navigation system. The orientation performance of the participants was better on the tactile display as compared to the conventional car navigation system in high load conditions, besides the fact that the majority of them were experienced users of the car navigation system. The participants were equally distracted on the secondary task in both the tactile display and the conventional car navigation system condition. In the following, we discuss our research questions according to our qualitative and quantitative findings:

Q1: How does the presentation of the multiple directions and distances with

a tactile display affect the cognitive workload of the driver in a high demanding condition?

Though, we cannot conclude from the results that a tactile display either increases or decreases the cognitive workload of the drivers as compared to a conventional car navigation system. The tactile display, however, helped the participants to navigate, and engage with the environment in high demanding conditions. Our findings do not support the findings of van Erp and van Veen [EV04] that the tactile display decreases the workload of the drivers.

This might have many reasons: (1) we compared the tactile display with a conventional car navigation system (visual and auditory), and the participants were experienced users of such a system, (2) our driving environment was more complex than in the car simulator, and the drivers had to take care of multiple security related aspects, and (3) we presented multiple directions with multiple distances with the tactile display.

Q2: How will the participant perform on secondary task while following the commands of a conventional car navigation system as compared to a tactile display?

The results do not indicate a major difference in the performance of the participants on the secondary task of PASAT between both conditions of the tactile display and the car navigation system. The results indicate that the orientation performance of the participants on the tactile display is better than the conventional car navigation system. Participant 2 made the least number of errors on PASAT, improved orientation performance, and a lower cognitive workload on both conditions. The participant was confident about the perception of the tactile display.

So, it shows that the reduction in cognitive workload causes a performance improvement. Similarly, participant 10 made a maximum number of errors on PASAT, made errors on the orientation performance, and had increased cognitive workload in the both conditions. Furthermore, the participant was unsure regarding the perception of the "front-left" and "front-right" direction. In this case, increased cognitive workload degraded the performance of the participant. In this study, we might conclude that the high cognitive workload cause decline in the performance of task, and it varies from person to person.

Q3: Which of the systems between the tactile display and conventional car navigation system will more distract the driver from a secondary task?

The results did not show a huge difference on the level of distraction of the participants from the secondary task PASAT in both conditions of the tactile display and the conventional car navigation system. Participant 1 was distracted the

most on PASAT among all participants, but showing lower cognitive workload in the conditions.

This means that the participant was less concentrating on the secondary task. Participant 5 was least distracted from the secondary task of PASAT in the condition of the tactile display and the conventional car navigation system. Furthermore, the participant showed a maximum decrease in performance on PASAT-2 sec. Being a beginner user of a conventional car navigation system, the participant showed less cognitive workload in the tactile display condition as compared to the conventional car navigation system. The results showed that less distracted participants showed a higher chance to carry out the secondary task which might result in an increase or decrease of their performance on the task according to difficulty level. We might conclude that if the car navigation systems will grab less attention, then the drivers will get a chance to perform other tasks in the car.

The results showed that counting a number of pulses in the tactile display was perceived as equally distracting as the conventional car navigation system (visual and auditory). In the training session, the male participants performed better on PASAT than the female participants. The female participants performed better on PASAT than the male participants on the conditions of the tactile display and the conventional car navigation system. This supports the findings [RZF09] that the women have better ability to do multitasking in the high load conditions.

Being beginner users of the tactile display, most of the participants were confident on their perception of the tactile display which encouraged the use of the tactile display in the car navigation systems. The tactile display helped the participant to engage with the environment. Most of the participants were experienced users of the conventional car navigation systems, and beginner users of the tactile display. We conducted our study in an urban environment. The tactile displays might, however, be helpful to decrease the reaction time in an emergency situation where the driver needs to observe the situation using visual and acoustic senses. So, we conclude that the tactile display can effectively complement visual and auditory interface for successful task fulfillment in high load conditions.

In this users study, we compared the tactile display only with the conventional car navigation system. The tactile display was providing the turn-by-turn route guidance on simple, flared, and channelized intersection. We need to evaluate the fully functional tactile display that will also support navigation on the roundabout intersections. So, this experiment is limited to the partially functioning tactile display. We aimed to find an answer to the question that the tactile display would replace or alter the existing car navigation system. For this, we conducted a users study in the next section to compare the three conditions i.e. the tactile display

only, conventional car navigation system, and combined (tactile & conventional system). We also want to investigate the effect of these displays on other visual and auditory tasks. The next user study will disclose performance of these displays in the provided conditions.

6.3 Experiment 2: Tactile Display Versus Conventional Car Navigation System Versus Combined (Tactile and Conventional System)

Tactile displays generally consist of vibrating components called *tactors* that are in contact with the skin [EV04]. These tactile displays have previously been evaluated to present information in the car navigation systems [BAH11]. Scott and Gray [SG08] investigated the effectiveness of the rear-end collision warning systems presented in the tactile, visual, and auditory modalities. They found that the tactile modality significantly reduced the reaction times of the drivers, and produced faster the driver responses to warning signals. Erp and Veen [EV04] measured the workload and reaction time on navigation messages in the visual, tactile, and multimodal displays. They found the fastest reaction time in multimodal displays. Furthermore, employing a tactile display instead of a visual display resulted in a lower mental effort rating and no performance decline when workload increased. Tactile displays, therefore, help to present navigation information in the high load conditions where it is loud and difficult for the driver to take his or her eyes off the road [AB10].

Previous research indicates that the tactile instructions are easier to perceive in the presence of a high visual and auditory workload. It is, however, unknown how the tactile car navigation systems affect the performances of the drivers on visual, and auditory secondary tasks while driving a car. In this case, the outcome of adding tactile feedback into conventional car navigation systems can be measured. Second, the outcome can be measured by replacing the conventional car navigation systems with tactile only systems. The user interfaces of the car navigation systems are required to examine the criteria of the effectiveness and efficiency according to Burnett [Bur00b]. The purpose of this study is to compare the efficiency, effectiveness and workload of the tactile displays with or without conventional car navigation systems.

6.3.1 A Tactile-based Navigation System

In Chapter 4 and Chapter 5, we explored the tactile parameters to present direction, distance, and roundabout information in the cars with the tactile displays. Figure 6.9 shows the tactile parameters suitable for presenting direction, distance, and roundabout information in the car navigation systems. The tactile parameter body location is best suited for presenting direction feedback in the cars that can be displayed with the *two vibrators front design* in Section 4.3. Simple intersections can, therefore, be presented to a driver with the help of direction signals. Furthermore, the parameters of intensity, rhythm, and duration are used to encode distance information which can be presented with the *rhythm and duration based distance encoding* in Section 4.4. The parameters used for direction and distance feedback are different, so both types of information can be presented simultaneously in one vibrotactile message. This information can be used to present the flared and the channelized intersections. Furthermore, rhythm, duration, and body location are appropriate to present the roundabouts intersection. Thus, the *direction-based* design in Chapter 5 is suitable for presenting the roundabouts. The roundabouts intersection is located distinct on the road than flared and channelized intersections. The tactile parameters can, therefore, be easily utilized to present different types of the road intersections to a driver.

6.3.2 Experiment Design

A person is driving a car with his wife and child. He has to pick up his friend in front of a new shopping mall that opened two days ago and he is unaware of its exact location. His wife told him something important regarding the insurance that they wanted to get for their child's education. Their child sometimes interrupts them and tells them his school friends' stories. To reach the desired location at the shopping mall, the driver is using a car navigation system. In this scenario, the driver has a lot of visual and auditory workload. The driver is listening to his wife and child, and looking for his friend. He is also following the visual and auditory instructions of the car navigation system. In this case, the availability of a vibration signal for the route guidance could be beneficial for the car driver. This user study will examine this assumption.

In this study, our goal is to investigate the performance of a driver on the secondary tasks under high load conditions, and using navigational help for the route guidance as in the above scenario. We examine the navigation performance of a driver using a third modality of a tactile display during the other visual and

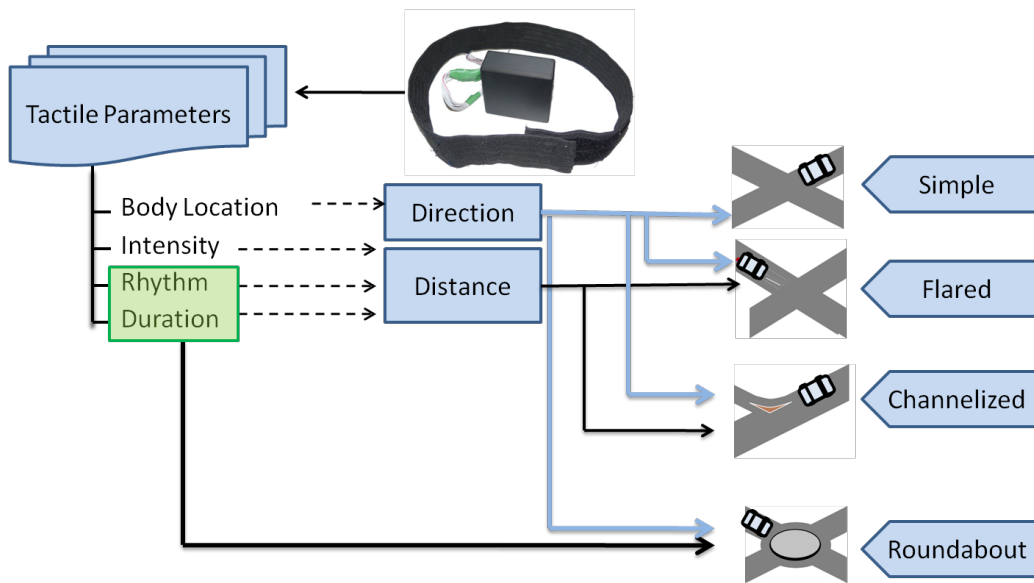

Figure 6.9: Tactile parameters that supports fully functional tactile based navigation system.

auditory tasks.

In this study, we compare the tactile displays, the tactile displays combined with conventional car navigation systems, and the conventional car navigation systems to assess the performance of visual and auditory secondary tasks. Each participant was evaluated for these factors in three driving sessions. In each driving session, the participant was required to perform an auditory task, i.e. listening to English comprehension, and a visual task, i.e. counting bus stops on the route.

We selected the task of "listening to English comprehension" because it is very close to a real-life situation. When people are talking in the car, the driver listens and sometimes speaks to them. The "counting of the bus stops" is a visual task that is comparable with a driver looking for some entity on the road.

Our independent measure was the route guidance of drivers using the tactile displays, tactile displays combined with conventional car navigation system, and conventional car navigation systems. In the following, we present the research questions of our evaluation.

Q1: How well did the drivers perform on secondary tasks using the tactile displays, the car navigation systems, and the tactile & car navigation systems?

Q2: Which of these systems is more efficient in terms of time?

Q3: On which of these three systems did the drivers make the least number of

errors in orientation decisions?

Q4: Which of these systems imposed the least amount of workload on the drivers?

Dependent Measures

The dependent measures of our evaluation are secondary task performance and distraction, completion time, orientation performance, and workload. The dependent measures are based on our research questions.

Secondary task performance and distraction

Participants were required to complete two types of secondary tasks: (1) listening to English comprehension (auditory task), and (2) counting bus stops (visual task).

Listening to English comprehension: We selected four different English listening comprehensions from the website about.com². The level of English comprehension was lower intermediate to intermediate since all participants were non-native English speakers. One from four recordings was played twice in each driving session. The driver had to listen to the recordings while driving and answer the related questions after each session. One recording was played twice before the driving sessions. We normalized the performance of the driver on the listening task using the following method.

1. Secondary task performance = Number of correct answers on room condition – Number of correct answers on driving condition with route guidance
2. Secondary task errors = Number of wrong answers on driving condition with route guidance – Number of wrong answers on room condition
3. Secondary task distraction = Number of missed answers on driving condition with route guidance – Number of missed answers on room condition

if (1) == 0 then
No change in performance
if (1) < 0 then

²<http://esl.about.com/library/quiz/bllisteningquiz.htm>

```

    Improved performance
    if (1) > 0 then
        Reduce performance
    end if
end if
if (2) == 0 then
    No change in errors on task
    if (2) < 0 then
        Reduce Errors
        if (2) > 0 then
            Increase Errors
        end if
    end if
end if
if (3) == 0 then
    No change in distraction from task
    if (3) < 0 then
        Less distraction
        if (3) > 0 then
            More distraction
        end if
    end if
end if

```

Counting bus stops: Counting bus stops was the other secondary task assigned to the participants in the three driving sessions. They had to count the number of bus stops on that route. Their performance was measured by matching the correct number of stops they counted on the way. If they forgot to count the bus stops, it was counted as a distraction.

Completion time: We calculated the completion time of each driving session. The driver was required to drive four times on each route using a tactile display, a conventional car navigation system, and a combined system. The average time for all sessions was calculated for the task completion.

Orientation performance: The number of errors in orientation decisions was counted to assess orientation performance. If participants followed the route shown by the route guidance system, it was measured as a correct orientation decision; otherwise, it was a wrong orientation decision.

Workload: The workloads of the participants were measured using the Rating Scale of Mental Effort (RSME) [Waa96]. Participants had to mark on the vertical axis the amount of effort for the completed task. The scale of the vertical axis was 0-150, i.e. from absolutely no effort to more than extreme effort.

Participants and Apparatus

We conducted this evaluation with 12 participants, 8 men and 4 women. Their average age was 33 years SD (± 6.9) and they had driving experience of 14.7 SD (± 7.6) years. Six drivers were experienced users, three beginner users, and three very experienced users of the car navigation system. There were eight beginners, two experienced and two very experienced users of the tactile belt.

We used a Volkswagen car in our experiment. We used the car navigation system which was integrated in Volkswagen during our experiment. The tactile belt (see Section 4) was provided for the navigation purposes in the car during the experiment.

The combined system was composed of the tactile based system explained in Section 6.3.1, and the conventional car navigation system integrated in Volkswagen. The experimenter sitting on the back seat of the car broadcasts the vibrotactile signals by following the instructions of the car navigation system. So, the tactile display was manually combined with the integrated car navigation system.

The English comprehension was played on the car speakers. We used the Rating Scale of Mental Effort [Waa96] questionnaire to measure mental workload.

Procedure

First, the whole experiment was explained to the participants. One clip of the English comprehension was played to the participants before leaving the venue. The participant twice listened to the clip and answered the related questions.

The participants were asked to wear the tactile belt before getting into the car. The sequence of all conditions was randomized to reduce learning effects. The driver was asked to drive from location "A" to location "B" using the first navigation helps in the sequence. The participant completed the listening English comprehension and counting the bus stops tasks during the driving session. Afterward, we asked the questions related to English comprehension to the participant. The participant marked the RSME questionnaire for this condition.

The same sequence of steps was followed for the second and third driving sessions. The tactile display was controlled by the experimenter. The experimenter

followed the instructions of the navigation systems and copied them to the tactile feedback in the same way. The experimenter sat on the back seat behind the driver's seat of the car. In the case of the tactile with navigation system, the experimenter followed all instructions and timings of the car navigation system, and provided tactile feedback accordingly.

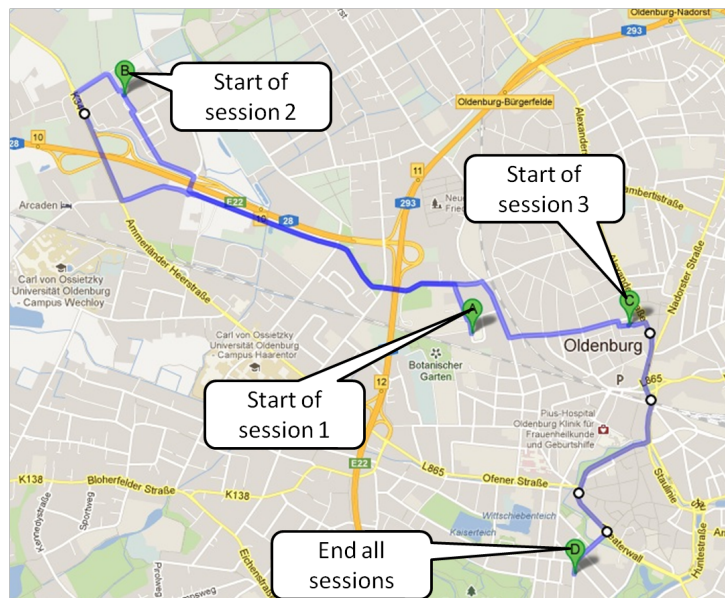

Figure 6.10: Trip during all three sessions of the experiment.

The total experiment took approximately 75 minutes. Sessions one, two, and three consisted of 3.4 km, 3.7 km, and 2.5 km drives respectively. Figure 6.10 shows the driving route during the experiment.

6.3.3 Quantitative Results

In the following, we present the quantitative results with respect to our dependent measures. Our measures contained performance of the participants on the secondary tasks, their orientation performance, session completion time, and workload. We collected the data of these dependent measures according to the procedure given in Section 6.3.2.

Performance on Secondary Task

The repeated measures ANOVA test found no significant differences in the performances of the secondary tasks in the conventional navigation system, the tactile display, and combined (tactile & conventional navigation system) conditions, Chi-square= 1.125, $p= 0.570$.

The data show no significant differences in responding to the wrong questions in the task of English comprehension in all conditions, Chi-square=4.181, $p=0.124$.

Participants were equally distracted from the secondary auditory tasks in all conditions, Chi-Square=0.254, $p=0.881$.

A significant difference was found in the performance of counting the bus stops in all conditions, Chi-square= 7.800, $p < 0.05$.

Participants performed significantly better on the tactile display as compared to the conventional car navigation system, $p < 0.05$ (effect size -0.42, large effect). Participants performed significantly better on the tactile display as compared to the combined, $p < 0.05$ (effect size -0.49, large effect).

Figure 6.11 shows the results of this visual secondary task. The graph is inclined towards 10 for the tactile display condition; this means that most participants completed the bus stop counting task successfully. For the combined condition, the graph is inclined towards 0; this means that many participants forgot to perform the secondary task. For the conventional navigation system, the graph is distributed widely; this means the various participants forgot to perform the secondary task, and others made mistakes.

Orientation Performance

There was no significant difference in the orientation performances of the participants for all conditions, $p=0.723$. The data also showed no significant difference in the performances of participants in reaching their destinations using the three configurations $p=0.615$.

Completion Time

There was no significant difference in the completion time of the driving sessions in all the three conditions, $p=0.421$. Figure 6.13 shows that the average route completion time was lower for the tactile display as compared to the conventional car navigation system, and combined conditions.

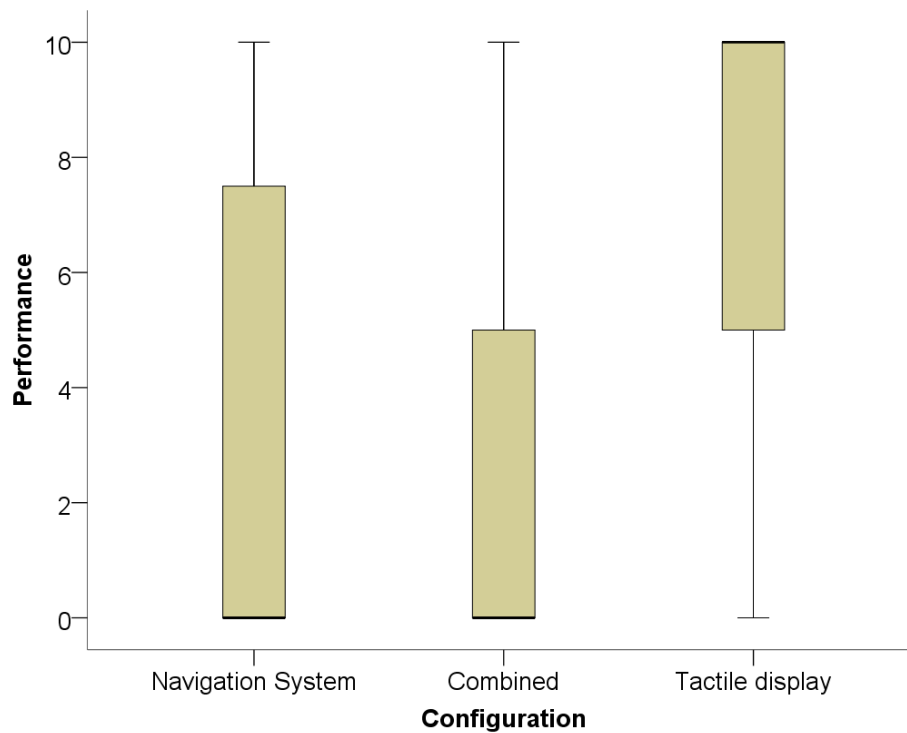

Figure 6.11: Performance of the participants on secondary visual task, y-axis presents lower performance 0 means forget doing this task to higher 10 completed task successfully.

Workload

The results indicated that the tactile interfaces imposed a significantly less workload in the tactile display condition as compared to the conventional car navigation system condition, $p < 0.05$ (effect size -0.42, large effect). There was a marginal difference in the tactile display condition and the combined condition, $p = 0.093$ (0.39 medium effect). Figure 6.14 indicates that the tactile display generated less workload as compared to the other two conditions.

6.3.4 Participants' Suggestion and Comments

We noted the drivers' comments and suggestions during, and after the driving sessions. Some are described next. "I truly managed to count the bus stops using the tactile belt, otherwise I had a mental map by looking at the visual display."

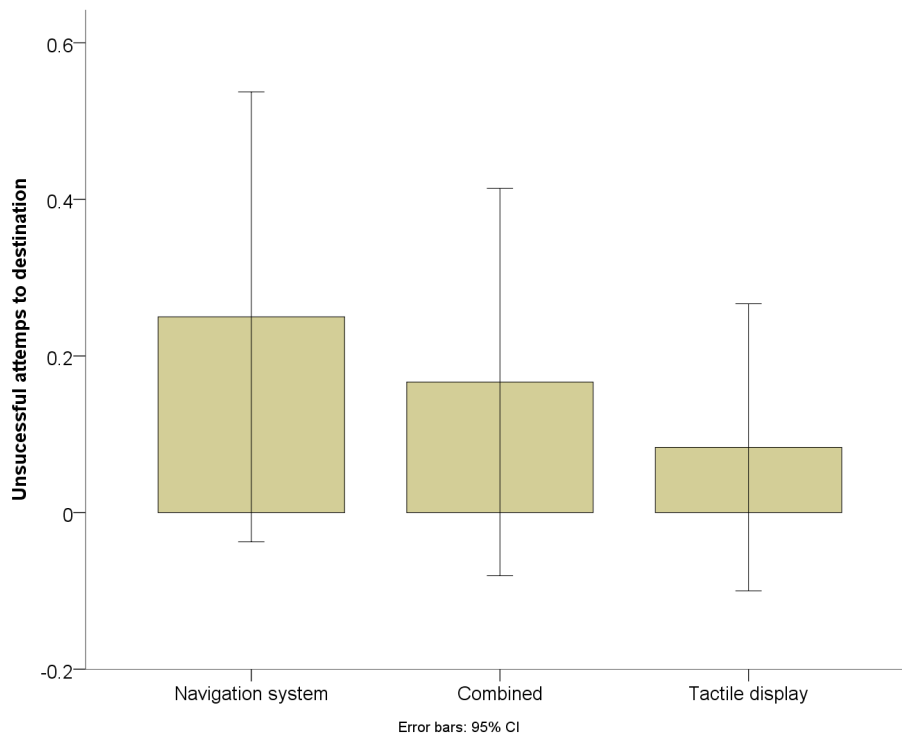

Figure 6.12: The participants unable to reach their destination using the tactile display, conventional car navigation system, combined (tactile display & conventional navigation system).

"The tactile only condition was much easier than audio; it would be difficult to have the tactile and audio, because of the overlay."

"My driving performance was worst with all the three modalities combined, but it would be nice if we could select the interface of our choice. Vibration is good but it needs visual support. We need a button to repeat the vibration signals if you cannot perceive it straightaway." "In this scenario, vibration was perfectly sufficient." "Vibration with distance was a problem in that you could not really know the exact distance; having the visual display helped you see it." "The combination of visual and tactile is perfect, and it is better than audio and visual." "I think the route differs a lot and I had to concentrate more on the street." "I miss the map while using the tactile display." "I think the tactile display is easiest to follow."

"I will miss the tactile feedback while driving with the conventional car nav-

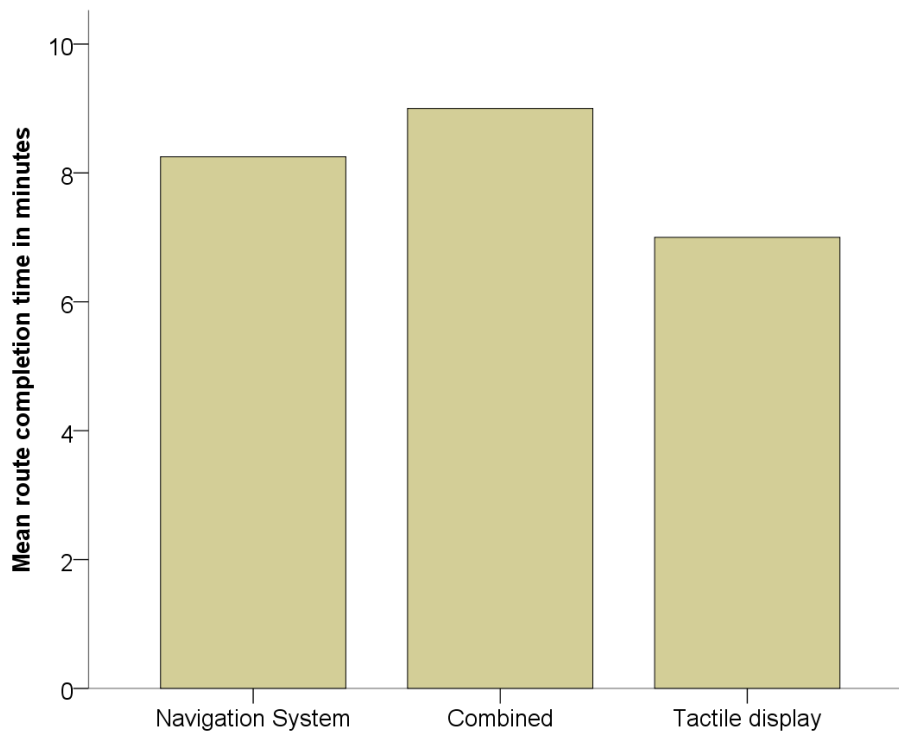

Figure 6.13: Route completion time in three conditions.

igation systems." "I prefer the tactile belt. I do not need to listen as much to the voice or look at the map to just have an overview." "Looking at the bus stops was very demanding; I would rather look for my child at a bus station."

"I think that the conventional navigation system was worst, because listening to the two voices was very difficult." "I think the approaching signals of the tactile display became more accurate." "If I could choose, I would prefer the tactile display and the radio." "It would be more convenient to have an integrated belt." "Distance signals with the tactile display are much better than the voice signals."

"Traffic has more influence on the workload than the navigation system." "Depends really on the traffic; we would be able to listen to a story at the long traffic lights." "It has plenty to do with a story. The combination was easiest than the navigation system only." "The combined system was better because it really helped me to find the last complicated turn with the tactile signal." "If you have a map, then you can look further ahead; so, the navigation system has a slight advantage." "The combination of the tactile display with audio is good if the streets are

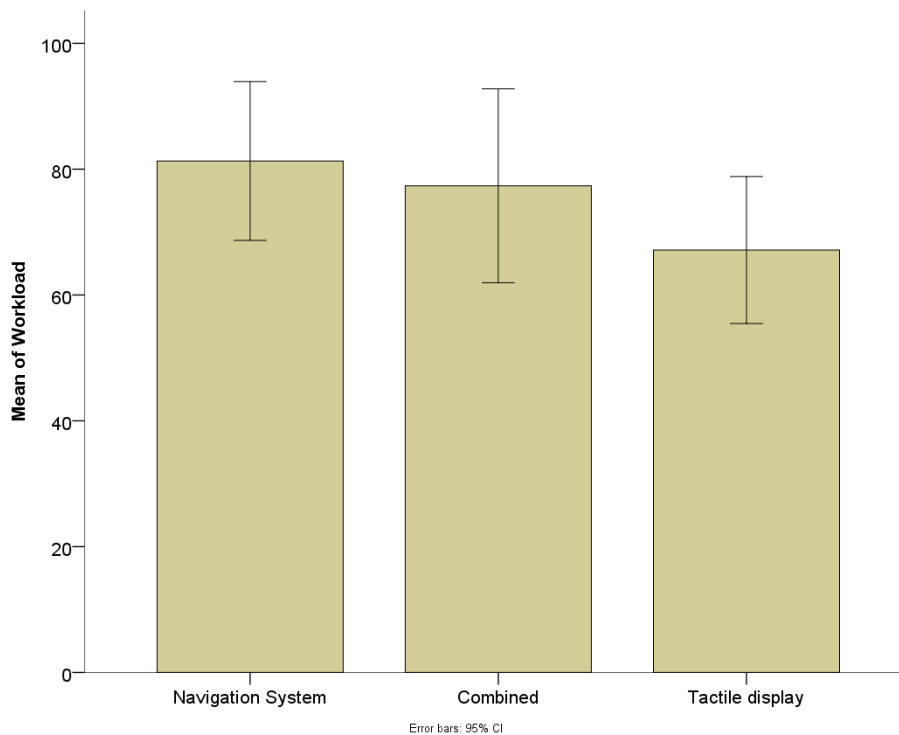

Figure 6.14: Comparison of drivers' workload in three conditions, they showed comparatively less workload on the tactile display as compared to other two conditions.

situated close to each other."

"The combination of the visual display with the tactile display is the best." "If I make a mistake, the visual display will help me correct it - otherwise the tactile display is better than the voice display."

"I would like to try the tactile belt with the visual display only and without audio signals because it is distracting." "I would like to have fewer signals, but more specific ones." "On simple streets, the distance information of the tactile display is too much, but on flared and complex streets, it is very helpful."

"It is still a navigation system because the visual display provides an overview at critical situations, and at normal road and situations the tactile display is better." "The pulses need to be more intense." "With the support of navigation information, the timing of pulses was better and more accurate." "The combined system provides too much information, and I could not listen to the voice." "The tactile

belt really works well on flared roads." "I need map support in difficult situations when the streets are located very close together."

"The vibration feedback is a reminder to look at the screen. It helps look at what street to turn into, and how far away it is. I have a similar car navigation system and I always forget to look at it, and just follow the sign behind my steering wheel." "The conventional car navigation system has a flaw at the roundabout; on left-hand driving roads, it instructs you to turn left and then left on the roundabout."

Nine participants preferred the combination of the visual, audio, and tactile displays. Ten participants preferred the conventional navigation system in the second place because it has a visual support. The tactile display was the most preferred system according to five participants. One participant said that he would prefer the tactile display or the navigation system dependent on the situation.

6.3.5 Discussion

A tactile display was compared with a traditional car navigation system and a combined tactile/visual/auditory system for the route guidance while drivers performed other visual and auditory secondary tasks. The overall results indicate that the tactile display was better in terms of the performance of the secondary tasks, and the cognitive workloads of the drivers. The qualitative results indicate that the tactile display was preferred in combination with either the visual or the auditory display for the navigational help in the cars. In the following, we discuss the results according to the research questions:

Q1: How well did the drivers perform on the secondary tasks using the tactile displays, the car navigation systems, and the tactile & car navigation systems?

The results indicate that the participants performed significantly better with the tactile only condition as compared with the conventional navigation system, and combined (tactile & conventional navigation) system conditions. No difference was, however, found in the performances of participants in all the three conditions on the auditory task only. The performances of participants increased on the visual secondary task using the tactile display. This means that the tactile display is helpful for presenting navigation instructions to a car driver when there is already a huge amount of visual and auditory tasks. Drivers are able to perform the secondary visual and auditory tasks properly with the availability of a third modality for important tasks, such as navigation. The qualitative results showed that it was not easy for the drivers to perform two secondary tasks simultaneously while driving with many modalities. In the tactile only condition they, however,

performed the both secondary tasks most successfully.

Q2: Which of these systems is more efficient in terms of time?

The results indicated no difference in the completion of driving tasks in the three conditions. This means that the presence of any kind of display does not affect the journey length in terms of time. It is more related to the type of the car navigation system and how it calculates the total route, and selects one of the routes on the basis of its length, traffic or presence of the traffic signs.

Q3: On which of these three systems did the drivers make the least number of errors in orientation decisions?

Drivers were able to orient in the environment and reach their destinations in all the three conditions. The visual display supports the map. This did not, however, make a significant difference in following the route or reaching the destination in all the three conditions. Drivers preferred to have a tactile display combined with a visual display to gain an overview of the environment, and consequently make fewest orientation errors.

Q4: Which of these systems imposed the least amount of workload on the drivers?

According to the results, the tactile display imposed the least amount of cognitive workload on the drivers. This means that information coming from multiple displays may overload a car driver with excessive information. The tactile only display helped the drivers receive information more easily without overloading them. We observed from the drivers' comments that they also preferred the tactile only condition to the audio condition. All the three modalities combined were disliked by the participants because of the excessive information.

The tactile system only, and combined with traditional car navigation systems was the prototype system. We expect to conduct other user studies with the functional tactile-based car navigation systems. These studies will be carried out on fixed routes on the urban roads of a German city, but the results are expected to have applicability to other urban scenarios.

We, therefore, conclude that a tactile display does not increase the cognitive workload as compared with the traditional car navigation systems. The display is found to be beneficial for the drivers to receive navigation instructions while they perform the other visual or auditory tasks.

6.4 Conclusion and Summary

This chapter explored the tactile channel only, and in combination with existing visual and auditory channels to present navigation information in a car. The experiments examined multiple variables, such as performance, efficiency, effectiveness, and workload by comparing the tactile display with the conventional car navigation systems, and with the tactile and conventional car navigation systems. In the first study, the drivers showed better orientation performance on the tactile only display. The results of the second study presented an improved performance of the drivers on the visual secondary tasks on vibrotactile navigation display. Drivers also reduced their workloads on the tactile display as compared with the conventional car navigation systems, and combined systems. The qualitative results, however, indicate that the drivers mostly prefer to have visual or auditory help with the tactile display.

The tactile display is found to be acceptable and the preferred channel of communication in the cars. This helps drivers concentrate on the navigational commands while performing other visual and auditory tasks. We conclude that a tactile display can be used as an alternative to existing visual or audio displays to present navigational information in the cars.

Chapter 7

Contributions and Future Work

This chapter concludes our dissertation. Section 7.1 summarizes the contributions of our work in the area of research which are published in [ABH12, BAH11, AB10, AHB10, AHB09]. Section 7.2 presents several possibilities for the future research.

7.1 Summary of Contributions

The work presented in this dissertation is focused on exploring the tactile parameters for the information presentation of different urban intersections. In the following, we summarize the contributions to our area of research.

7.1.1 The Alternative User Interface in Car Navigation Systems

Our main contribution is to investigate the navigational information that can be presented with a tactile user interface in the cars. We implemented the approach of analyzing different road intersections for the presentation of vibrotactile information. The driver needs to know the directions to follow at intersections for successful navigation. It is, therefore, possible to present vibrotactile signals discretely to present navigation instructions to avoid annoying the driver all the time.

In this thesis, we successfully investigated a tactile user interface for the presentation of navigation information in cars [AHB10, AB10]. The results of our study make it possible to fully integrate a vibrotactile-based navigation system in cars that is explained in Section 6.3.1. A step forward from the proof-of-concept

studies where the feasibility of a tactile display has been studied in the car navigation systems, we explored a functional vibrotactilebased car navigation system in our thesis. The findings of our research can be applied to most urban road scenarios. This might contribute to the requirements of commercial companies involved in developing the car navigation systems.

This interface allows more safety by enabling a hands-on controls strategy by not grabbing any visual and auditory attention which is more often required in other driving tasks. This interface enables quiet communication between the driver and the car without involving other passengers. This interface might also be beneficial for disabled persons (e.g. deaf drivers) to communicate with the car navigation systems other than using the visual interface. This interface might be further explored to provide feedback to disabled drivers to make navigation easier for them.

7.1.2 Information Presentation in Visual and Audio Information Overloaded Environment

The area of human-machine interaction often deals with different user interfaces. The most conventional and common user interfaces of interest are visual and auditory interfaces. This is why visual and auditory user interfaces are present in most devices and systems. In certain environments, such as in a car, visual and auditory interfaces are present in more than one devices. This means visual and auditory information coming from multiple sources which often overloads a driver visually and acoustically. In our thesis, the investigation of the tactile modality made it possible to provide another channel of communication in overloaded car environments.

We conducted the evaluations, in Chapter 6, of the feasibility of tactile interfaces in audio and visually overloaded environments. The results provide a comparison of conventional car user interfaces with the tactile display in high workload situations. We found that a tactile interface could present complex navigational information in high load driving conditions in which drivers were required to observe the traffic situation with their visual and auditory senses.

7.1.3 Usability Measurement in Automotive User Interface

In this thesis, the methods of measuring the usability of a tactile display are presented in Chapter 4 and Chapter 5. A number of experiments show that it is possi-

ble to investigate most of the usability factors. Mostly, these usability factors can be measured quantitatively. These methods include questionnaires and measuring error rates. Among the questionnaire methods, the SUS (System Usability Scale) method was found to be successful for measuring the usability of a tactile display while driving a car. This method allowed us to measure a number of usability factors, such as frequency, complexity, ease of use, support from a technical person, integration, inconsistency, learning ability, confidence, and practice. Performance was mostly evaluated by measuring the number of errors that a driver made in the identification of the vibrotactile signal.

We adapted a simple approach that did not require too many data collection resources, such as sensors. We used the "thinking aloud" method, i.e. when a driver needs to say the meaning of every vibrotactile signal that he or she feels. Then, we counted the number of correct responses. This is an inexpensive method that does not require any device to capture the users data. This method can also be used regardless of the availability of resources. This method might result in the least amount of data ambiguity. We also considered the oral reports of drivers as a qualitative usability measuring method. Most of the time, the distractions of the driver were measured by observation methods. We also involved participants in a secondary task, in which distractions were measured by counting the number of times they missed the task.

Therefore, several usability measuring methods were successfully used in our thesis. In the future, this might provide a proof-of-concept for evaluating novel displays in cars.

7.1.4 Application of Tactile User Interface from One Domain to Another

In our thesis, the tactile interface was successfully investigated in a car. A car is a moving object and we found such an interface to be feasible when moving at some speed. Our study shows the possibility of using the tactile interfaces in other similar objects. This will provide an opportunity to use an additional interface along with conventional interfaces.

Formerly, the tactile interface was used to provide route support to the handicapped Persons and pedestrians. Therefore, this idea was evolved inside the car navigation systems. In our thesis, we found interesting results regarding the tactile feedback. The approach of presenting vibrotactile feedback is flexible to apply in other domains. The vibrotactile design in our thesis might be explored further to

present the information in other areas for route guidance support.

Tourist support with a tactile display is another area of research interest. We explored turn-by-turn vibrotactile information presentation. The results of our study can be modified to present information to cyclists. Similarly, the results might be beneficial for all domains that use turn-by-turn navigation e.g. in motor-cycles, ships and buses.

7.2 Future Work

This work demonstrates the non-visual and non-acoustic technique of presenting navigation information inside the cars. In this section, a variety of future applications is high-lighted.

7.2.1 In-car Information Presentation

We explored potential vibrotactile parameters to present in-vehicle information. Discrete vibrotactile information presentation is valued over continuous signals in Section 4.2. This provides evidence of acceptability of vibrotactile information in moving objects, such as cars but in a specific manner. These findings may help researchers design the future car user interfaces.

Up to three categories of distance (Section 4.1) were mostly liked by drivers on urban roads. In the future, we are planning to evaluate four categories of distance on motor-ways. It is expected that these four categories of distance are more appropriate on long routes where turns come after a long time and drivers need more feedback.

In this study, we conducted all experiments on urban roads. In order to apply the findings to motorway scenarios, further studies are needed in that context. In the future, we are planning to evaluate vibrotactile encodings on motorways. The vibrotactile designs of the car navigation systems can, therefore, be generalized on not only urban roads but also motorways.

We evaluated our research designs on single lane and compact roundabouts in Chapter 5. The results of our study give us many design ideas which are helpful for further evaluations. In the future, we will explore vibrotactile designs on more complex types of roundabouts, such as double lane roundabouts.

This study is missing an investigation of the timing of vibrotactile information presentation with respect to distance and speed. Mostly, evaluations were carried

out by copying the voice prompts or following the absolute distance for vibrotactile feedback. In the future, we are planning to present models of the appropriate timings of vibrotactile information presentation in the car navigation systems by considering all factors, such as distance and speed.

In this thesis, we promised quiet communication between the driver and the car navigation system. The interface can thus be beneficial for disabled drivers. Future evaluations are planned with specific deaf participants to check the feasibility of vibrotactile-based car navigation systems. The results might also be further transferred to other in-car systems for the facilitation of such users.

The evaluations and vibrotactile designs presented in this thesis provide the fundamental to tactile based car navigation systems. The outcomes of our thesis can be combined with the other theoretical foundations to build commercial tactile based car navigation systems in future.

7.2.2 Multimodal (Visual, Audio, and Tactile) Car Navigation System

In Chapter 6, we evaluated the tactile display only and in combination with existing car navigation systems (visual and audio). In this thesis, we manually combined the tactile modality with the existing user interfaces of the car navigation system. The experimenter was involved by copying the instructions from the navigation system and triggering the tactile feedback accordingly. In the future, we are planning to explore automatic tactile-based car navigation systems. In order to accomplish this, a tactile interface is needed to explore synchronization with existing car navigation systems. A study is also expected to assess the acceptability of a car navigation system with three modalities. It is required to investigate which of the visual and auditory modality can be replaced with the tactile display.

The results of Chapter 4 indicate that drivers need support from at least one interface (visual or audio) with the tactile interface. Therefore, our system is not supposed to replace existing systems, but it can be used as an alternative system.

In the future, algorithms will be required to explore the suitability of tactile feedback with the available GPS signals. These algorithms can be time-dependent and should consider the speed of the car. For example, an auditory feedback trigger, such as turn left after 200 meters. It could, therefore, be further evaluated when it is appropriate to trigger "far" signals in tactile-based car navigation systems. In this thesis, we explored the design of vibrotactile feedback on different kinds of urban road intersections. It, however, remains for the future research how

these designs can be actually used in practice with existing navigation technologies.

Appendix A

Usability Questionnaire of Distance Experiment

Description:

Aim of this experiment is to evaluate navigational information design with the help of tactile display. The three presented design solutions are "duration and rhythm based encoding", "intensity and rhythm based encoding", and "only rhythm based encoding". Drivers have to drive on three different routes for three design solutions. Goal of participants is to reach from origin to destination. The tactile belt will display distances from next Waypoint in different vibration patters in left or right direction. The categories of distances presented with respect to Waypoint are "Very far", "Far", "Near", and "Turn Now". These distances can be varying according to the length of the route. E.g. sometimes it can be "Near" and "turn Now". We will make video during experiment process. We promise your personal data will only be used for research purpose. If you have no objection on making video please sign in given space. Thank you for your participation.

Demographic Information:

- Time of Experiment: _____
- Gender:
 1. Male
 2. Female
- Age:

- Driving experience:

Design Type:

Q1 Please rate your information perception success every time by using this design?

Never										Always
1	2	3	4	5	6	7	8	9	10	

Q2 Please rate you have learned this interface information easily?

Very difficult										Very easy
1	2	3	4	5	6	7	8	9	10	

Q3 Please rate you expression regarding this information design?

Terrible										Wonderful
1	2	3	4	5	6	7	8	9	10	

Q4 rate that you are able to perceive all information in given time interval (e.g. in 1sec)?

Not Agree										Strongly agree
1	2	3	4	5	6	7	8	9	10	

Q5 Please rate, you can achieve better performance by using tactile displays in future?

Never										Always
1	2	3	4	5	6	7	8	9	10	

Appendix B

System Usability Questionnaire

Experiment _____ Task _____ Participant _____

1. I think that I would like to use this system frequently

Disagree				Agree

2. I found the system unnecessarily complex

Disagree				Agree

3. I thought the system was easy to use

Disagree				Agree

4. I think I would need the support of a technical person to be able to use this system

Disagree				Agree

5. I found the various functions in this system were well integrated

Disagree				Agree

6. I thought this system was too inconsistent

Disagree				Agree

7. I would imagine that most people would learn to use this system quickly

Disagree				Agree

8. I found the system very cumbersome to use

Disagree				Agree

9. I felt very confident using the system

Disagree				Agree

10. I needed to learn a lot of things before I could get going with this system

Disagree				Agree

Appendix C

Workload Questionnaire (RSME)

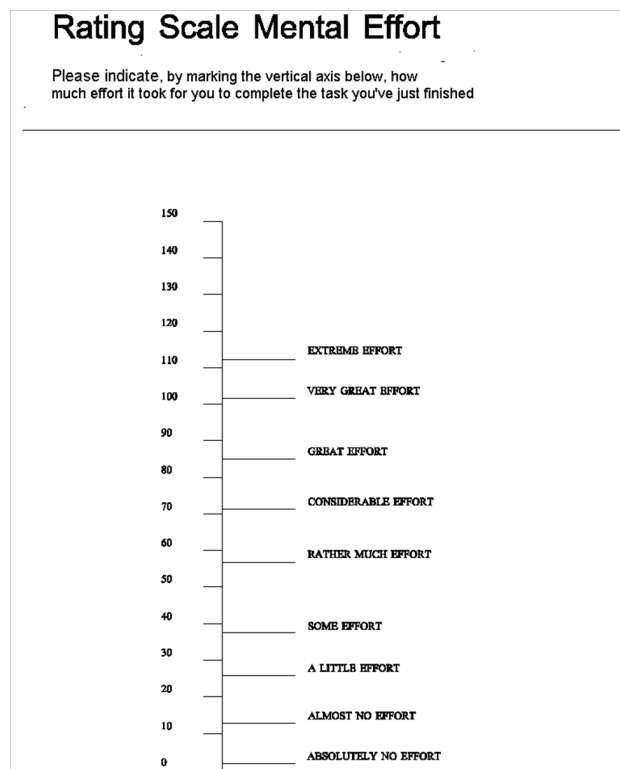

Appendix D

Workload Questionnaire (NASA TLX)

Experiment _____ Task _____ Participant _____

Mental Demand How much mental and perceptual activity was required (e.g. thinking, deciding, calculating, remembering, looking, searching, etc)? Was the task easy or demanding, simple or complex, exacting or forgiving?

0	1	2	3	4	5	6	7	8	9	10	11	12	13	14	15	16	17	18	19	20
---	---	---	---	---	---	---	---	---	---	----	----	----	----	----	----	----	----	----	----	----

Physical Demand How much physical activity was required (e.g. pushing, pulling, turning, controlling, activating, etc.)? Was the task easy or demanding, slow or brisk, slack or strenuous, restful or laborious?

0	1	2	3	4	5	6	7	8	9	10	11	12	13	14	15	16	17	18	19	20
---	---	---	---	---	---	---	---	---	---	----	----	----	----	----	----	----	----	----	----	----

Temporal Demand How much time pressure did you feel due to the rate or pace at which the tasks or task elements occurred? Was the pace slow and leisure or rapid and frantic?

0	1	2	3	4	5	6	7	8	9	10	11	12	13	14	15	16	17	18	19	20
---	---	---	---	---	---	---	---	---	---	----	----	----	----	----	----	----	----	----	----	----

Performance How successful do you think you were in accomplishing the goals of the task set by the experimenter (or yourself)? How satisfied were you

with your performance in accomplishing these goals?

0	1	2	3	4	5	6	7	8	9	10	11	12	13	14	15	16	17	18	19	20
---	---	---	---	---	---	---	---	---	---	----	----	----	----	----	----	----	----	----	----	----

Effort How hard did you have to work (mentally and physically) to accomplish your level of performance?

0	1	2	3	4	5	6	7	8	9	10	11	12	13	14	15	16	17	18	19	20
---	---	---	---	---	---	---	---	---	---	----	----	----	----	----	----	----	----	----	----	----

Frustration Level How insecure, discouraged, irritated, stressed and annoyed versus secure, gratified, content, relaxed and complacent did you feel during the task?

0	1	2	3	4	5	6	7	8	9	10	11	12	13	14	15	16	17	18	19	20
---	---	---	---	---	---	---	---	---	---	----	----	----	----	----	----	----	----	----	----	----

Select the member of each pair that provided the most significant source of workload variation in the task (by drawing a circle around it).

Physical D.	Mental D.	Temporal D.	Physical D.	Effort	Temporal D.
Temporal D.	Mental D.	Performance	Physical D.	Frustration	Temporal D.
Performance	Mental D.	Effort	Physical D.	Effort	Performance
Effort	Mental D.	Frustration	Physical D.	Frustration	Performance
Frustration	Mental D.	Performance	Temporal D.	Effort	Frustration

Appendix E

Technology Acceptance Model (TAM)

Purpose

Purpose of our evaluation is to investigate acceptability of tactile belt for directional information in automobiles. The experiment lab contains driving video on the screen of monitor and tactile belt, which will be worn around waist of participant. The participant needs to observe environment and directional signals will be displayed with the help of activating vibrators on the left, right, and on straight position. After observation participant need to express his acceptability of tactile belt by answering questions. All personal information will be kept confidential.

a) Demographic

1. Gender

- Male
- Female

2. Age

18-25 26-30 31-40 51-60 61-70

3. Driving experience (in years)—————

b) Questionnaire

1. Using tactile belt for directional information will enable me to accomplish navigation task more quickly

Likely						Unlikely
Extremely	Quite	Slightly	Neither	Slightly	Quite	Extremely

2. Using tactile belt will make it easier to navigate in environment

Likely						Unlikely
Extremely	Quite	Slightly	Neither	Slightly	Quite	Extremely

3. Using tactile belt will improve my task fulfillment (e.g. reaching on destination by following shortest route and on the time)

Likely						Unlikely
Extremely	Quite	Slightly	Neither	Slightly	Quite	Extremely

4. Using tactile belt will enhance effectiveness on navigation (e.g. deciding to take right lane on correct time)

Likely						Unlikely
Extremely	Quite	Slightly	Neither	Slightly	Quite	Extremely

5. Tactile belt will improve navigation performance during driving

Likely						Unlikely
Extremely	Quite	Slightly	Neither	Slightly	Quite	Extremely

6. I think tactile belt is useful in direction information judgment

Likely						Unlikely
Extremely	Quite	Slightly	Neither	Slightly	Quite	Extremely

7. Learning to operate tactile belt would be easy for me

Likely						Unlikely
Extremely	Quite	Slightly	Neither	Slightly	Quite	Extremely

8. I will find it easy to notice direction information with tactile belt

Likely						Unlikely
Extremely	Quite	Slightly	Neither	Slightly	Quite	Extremely

9. My interaction with tactile belt are clear and understandable

Likely						Unlikely
Extremely	Quite	Slightly	Neither	Slightly	Quite	Extremely

10. I think tactile belt is flexible to interact with

Likely						Unlikely
Extremely	Quite	Slightly	Neither	Slightly	Quite	Extremely

11. It will easy for me to become skillful in using the tactile belt

Likely						Unlikely
Extremely	Quite	Slightly	Neither	Slightly	Quite	Extremely

12. I think that tactile belt is easy to use

Likely						Unlikely
Extremely	Quite	Slightly	Neither	Slightly	Quite	Extremely

List of Figures

1.1	Types of task while driving the car.	4
1.2	Research work in this thesis according to experimental approach. .	7
2.1	Generalizing the model of perception [HR71].	10
2.2	Model of parallel processing of human senses by [HR71].	11
2.3	The basic geometric concept of orientation with the help of lines, points, and angles [HT73].	15
2.4	Visualization of model of task interference discussed in [HW03]. .	19
2.5	Illustration of tactile parameters.	23
2.6	Types of route guidance.	30
2.7	Modules of route guidance system proposed by Zhao in [Bur98]. .	31
3.1	(a) Simple intersection, (b) flared intersection, (c) channelized in- tersection, and (d) roundabout intersection.	39
3.2	Route guidance on urban road.	42
4.1	The tactile belt.	53
4.2	Overview of Chapter 4.	54
4.3	Three pulses of the vibrotactile signal on "front-left" side of the tactile belt indicate that the car is approaching the calculated crossing after covering the "far" distance.	55
4.4	The direction and distance instruction presented by the tactile feedback, as the car approaches the crossing.	57
4.5	A pre-recorded route is played in front of the participant.	59
4.6	Synchronization of video chip with tactile track with the belt vi- bration distance.	59
4.7	Survey setup.	60
4.8	Results of perceived usefulness and perceived ease of use.	61

4.9	Locations of different vibrators on the tactile belt showing eight directions to a driver.	63
4.10	One vibrator design (block design): One vibrator on a particular side is activated to present the respective direction.	65
4.11	Two vibrators front design: The front-left or front-right vibrator is activated to present a particular direction.	65
4.12	Two vibrators side design: The left and front-left vibrators or the right and front-right vibrators are activated to present a particular direction.	66
4.13	The driver wearing the tactile belt.	72
4.14	Route of evaluation.	74
4.15	The drivers preferences on each vibrotactile encoding for direction presentation.	75
4.16	The errors made by the participants for identification of direction on the given signal, in three vibrotactile encodings. The participants made least number of errors in the <i>two vibrators front</i> encoding for the all directions.	76
4.17	Usability score of <i>one vibrator design</i>	77
4.18	Usability score of <i>two vibrators front design</i>	77
4.19	Usability score of <i>two vibrators side design</i>	77
4.20	Usability measures of the <i>one vibrator, two vibrators front, and two vibrators side</i> encodings, based on SUS questionnaire.	78
4.21	Workload comparison of the <i>one vibrator, two vibrators front, and two vibrators side</i> encodings, based on NASA TLX questionnaire.	79
4.22	Rhythm based distance encoding consists of different patterns of pulses for different categories of distance.	86
4.23	Rhythm & intensity based distance encoding consists of different patterns of pulses with different intensity levels.	87
4.24	Rhythm & duration based distance encoding consists of different patterns of pulses for different categories of distance.	88
4.25	The experiment setup.	93
4.26	Three routes are used for driving in the experiment.	95
4.27	Preference ratings for the different tactile designs.	97
4.28	Learnability results.	97
4.29	Ease of information perception results.	98
4.30	Time lengths of signals results.	99
4.31	Error rates in recognizing distance categories in relation to all three designs.	100

4.32	Drivers' recognition of distance categories in the rhythm based distance encoding.	101
4.33	Drivers' recognition of distance categories in the rhythm <i>and</i> intensity based distance encoding.	102
4.34	Drivers' recognition of distance categories in the rhythm <i>and</i> duration based distance encoding.	103
4.35	Workload on drivers while driving on all three vibrotactile designs.	104
5.1	Overview of Chapter 5.	110
5.2	Take the first exit which is on the right with respect to the entry point.	112
5.3	Different stages of crossing a roundabout.	114
5.4	Vibrators location on the tactile belt used in experiments.	115
5.5	Vibrotactile design based on the concept of the typical visual display in conventional navigation system for conveying the n-th exit of a roundabout into a certain direction (direction-based design).	116
5.6	Vibrotactile design based on the concept of typical auditory announcements in conventional navigation system for taking the n-th exit of a roundabout (count-based design).	117
5.7	Vibrotactile design based on the concept of typical visual and auditory information in conventional navigation system for navigating through the roundabout (direction-based-and count-based design).	118
5.8	Visualization of <i>direction-based</i> design.	122
5.9	Visualization of <i>count-based</i> design.	123
5.10	Visualization of <i>direction-and-count-based</i> design.	124
5.11	Map of urban single-lane roundabout.	127
5.12	The participants' performance on the three vibrotactile roundabout designs.	129
5.13	The participants ranking of the vibrotactile roundabout encodings.	130
5.14	The participants' cognitive workload measure while performing on different vibrotactile roundabout designs.	131
5.15	<i>Direction-and-count-based</i> design is not well integrated as compared to other two designs.	132
5.16	<i>Direction-and-count-based</i> design is more inconsistent as compared to other two designs.	133
5.17	<i>Direction-and-count-based</i> design is more cumbersome to use as compared to other two designs.	134

5.18	The <i>direction-based</i> design is more confident to use than other two designs.	135
5.19	Usability measures of <i>direction-based</i> , <i>count-based</i> , and <i>direction-and-count-based</i> designs.	136
6.1	Overview of Chapter 6.	142
6.2	Car navigation system RNS-310.	146
6.3	Map showing the route taken by the drivers for experiment.	148
6.4	Measurement of cognitive workload of the participants.	149
6.5	Male and female difference of cognitive workload.	149
6.6	Comparison of performance of the participants on PASAT-3 sec and PASAT-2 sec on the conditions of car navigation system, and the tactile display.	150
6.7	Comparison of drivers' orientation performance on conventional car navigation system and the tactile display.	151
6.8	Comparison of distraction of the participants on PASAT-3 sec, and PASAT-2 sec on the conditions of car navigation system, and the tactile display.	152
6.9	Tactile parameters that supports fully functional tactile based navigation system.	158
6.10	Trip during all three sessions of the experiment.	162
6.11	Performance of the participants on secondary visual task, y-axis presents lower performance 0 means forget doing this task to higher 10 completed task successfully.	164
6.12	The participants unable to reach their destination using the tactile display, conventional car navigation system, combined (tactile display & conventional navigation system).	165
6.13	Route completion time in three conditions.	166
6.14	Comparison of drivers' workload in three conditions, they showed comparatively less workload on the tactile display as compared to other two conditions.	167

List of Tables

3.1	Information required to display on different urban road intersections in the car navigation system.	44
4.1	The percentage scores indicate errors made by the participants to identify the directions in all designs.	68
4.2	The quantitative categories of four distances.	86

Bibliography

- [AB10] ASIF, Amna ; BOLL, Susanne: Where to turn my car? Comparison of a Tactile Display and a Conventional Car Navigation System under High Load Condition. In: *AutomotiveUI '10*, 2010
- [ABH12] ASIF, Amna ; BOLL, Susanne ; HEUTEN, Wilko: Right or Left: Tactile Display for Route Guidance of Drivers. In: *IT-Information Technology* 54(4) (2012), S. 188–198
- [AHB09] ASIF, Amna ; HEUTEN, Wilko ; BOLL, Susanne: Acceptance of Tactile Belts for Directional Information Representation in Automobiles. In: *In adjunct proceedings of AutomotiveUI, Essen, Germany, September, 2009.*, 2009
- [AHB10] ASIF, Amna ; HEUTEN, Wilko ; BOLL, Susanne: Exploring Distance Encodings with a Tactile Display to Convey Turn by Turn Information in Automobiles. In: *NordiCHI2010*, 2010
- [All07] ALLEN, Gary L. (Hrsg.): *Applied spatial cognition: from research to cognitive technology*. Lawrence Erlbaum Associates, Mahwah, NJ, USA, 2007
- [BAH11] BOLL, Susanne ; ASIF, Amna ; HEUTEN, Wilko: Feel Your Route: A Tactile Display for Car Navigation. In: *IEEE Pervasive Computing* 10 (3) (2011), S. 35–42
- [BB04] BREWSTER, Stephen ; BROWN, Lorna M.: Tactons: structured tactile messages for non-visual information display. In: *AUIC '04 Proceedings of the fifth conference on Australasian user interface - Volume 28*, 2004

- [BBP05] BROWN, Lorna M. ; BREWSTER, Stephen A. ; PURCHASE, Helen C.: A First Investigation into the Effectiveness of Tactons. In: *In Proc. World Haptics 2005, IEEE, 2005*
- [BCL⁺06] BALZANO, Julie ; CHIARAVALLOTI, Nancy ; LENGENFELDER, Jeannie ; MOORE, Nancy ; ; DELUCA, John: Does the scoring of late responses affect the outcome of the paced auditory serial addition task (PASAT)? In: *Archives of Clinical Neuropsychology* 21(8) (2006), S. 819–825
- [BJS09] BACH, Kenneth M. ; JÆGER, Mads G. ; SKOV, Mikael B. ; AALBORG, Nils Gram T.: Interacting with in-vehicle systems: understanding, measuring, and evaluating attention. In: *BCS-HCI2009, 2009*
- [BNG99] BROOKS, Aaron ; NOWAKOWSKI, Christopher ; GREEN, Paul: Turn-by-Turn Displays versus Electronic Maps: An On-the-Road Comparison of Driver Glance Behavior / The University of Michigan: Transportation Research Institute. 1999. – Forschungsbericht
- [BP02] BURNTT, Gary E. ; PORTER, J. M.: An Empirical Comparison of the Use of Distance Versus Landmark Information Within the Human-Machine Interface for Vehicle Navigation Systems. In: *Human Factors in Transportation, Communication, Health, and the Workplace, 2002*
- [Bri05] BRILON, Werner: Roundabouts : A State of the Art in Germany. In: *The National Roundabout Conference, Vail, Colorado, 2005*
- [Bri08] BRILON, Werner: Roundabouts in Germany. In: *National Roundabout Conference, 2008*
- [Bro96] BROOKE, John: SUS: A quick and dirty usability scale. In: *Usability evaluation in industry, 1996*
- [Bur98] BURNETT, Gary E.: *Turn right at the King's Head" Drivers' requirements for route guidance information*, Loughborough University, Diss., 1998

- [Bur00a] BURNETT, Gary E.: "Turn right at the traffic lights" The requirement for landmarks in vehicle navigation systems. In: *The Journal of Navigation* 53 (3) (2000), S. 499–510
- [Bur00b] BURNETT, Gary E.: USABLE VEHICLE NAVIGATION SYSTEMS: ARE WE THERE YET? In: *Vehicle Electronic Systems 2000 - European conference and exhibition, ERA Technology Ltd, 2000*
- [BW09] BALDAUF, Daniel ; WITTMANN, Marc: Time perception as a workload measure in simulated car driving. In: *Applied Ergonomics* 40(5) (2009), S. 929–935
- [Cao11] CAO, Yujia ; CAO, Yujia (Hrsg.): *Multimodal Information Presentation for High-Load Human Computer Interaction*. SIKS Dissertation Series, 2011
- [CF78] CARTERETTE, Edward C. (Hrsg.) ; FRIEDMAN, Morton P. (Hrsg.): *Handbook of Perception: Feeling and Hunting*. Academic Press, 1978
- [CMM08] CHAN, A. ; MACLEAN, K. ; MCGRENERE, J.: Designing haptic icons to support collaborative turn-taking. In: *Int. J. Human-Computer Studies* 66 (2008), S. 333–355
- [CVT06] CARDIN, Sylvain ; VEXO, Frederic ; THALMANN, Daniel: Vibro-Tactile Interface for Enhancing Piloting Abilities During Long Term Flight. In: *Journal of Robotics and Mechatronics* 18 (4) (2006), S. 381–391
- [Dav89] DAVIS, Fred D.: Perceived usefulness, perceived ease of use, and user acceptance of information technology. In: *MIS Quarterly* 13 (3) (1989), S. 319–339
- [Day71] DAY, Ross H. (Hrsg.): *Human Perception (Basic Topics in Psychology)*. John Wiley & Sons Australasia Pty Ltd., 1971
- [DFAB03] DIX, Alan ; FINLAY, Janet E. ; ABOWD, Gregory D. ; BEALE, Russell ; DIX, Alan (Hrsg.) ; FINLAY, Janet E. (Hrsg.) ; ABOWD, Gregory D. (Hrsg.) ; BEALE, Russell (Hrsg.): *Human-Computer Interaction (3rd Edition)*. Prentice-Hall, Inc., 2003

- [DGSH09] DANIELS, Patricia S. ; GURA, Trisha ; STEIN, Lisa ; HITCHCOCK, Susan T.: *Body: The Complete Human*. National Geographic Society, 2009
- [EAYM01] ENRIQUEZ, Mario ; AFONIN, Oleg ; YAGER, Brent ; MACLEAN, Karon: A pneumatic tactile alerting system for the driving environment. In: *PUI '01 Proceedings of the 2001 workshop on Perceptive user interfaces*, 2001
- [EGB06] ERP, J. B. F. ; GROEN, Eric L. ; BOS, Jelte E.: A Tactile Cockpit Instrument Supports the Control of Self-Motion During Spatial Disorientation. In: *Human Factors: The Journal of the Human Factors and Ergonomics Society* 48 (2006), S. 219–228
- [EKC⁺97] EBY, David W. ; KOSTYNIUK, Lidia P. ; CHRISTOFF, Carl ; HOPP, Michelle L. ; STREFF, Fredrick M.: An On-the-Road Comparison of in-Vehicle Navigation Assistance Systems: The FAST-TRAC Troika Study / UMTRI: The University of Michigan Transportation Research Institute. 1997. – Forschungsbericht
- [Erp02] ERP, Jan B. F.: Guidelines for the Use of Vibro-Tactile Displays in Human Computer Interaction. In: *Eurohaptics 2002*, 2002
- [Erp05] ERP, J.B.F. van: Vibrotactile spatial acuity on the torso: effects of location and timing parameters. In: *Proceedings of the First Joint Eurohaptics Conference and Symposium on Haptic Interfaces for Virtual Environment and Teleoperator Systems*, 2005, S. 80–85
- [EV01] ERP, J.B.F. van ; VEEN, H.A.H.C van: Vibro-Tactile Information Presentation in Automobiles. In: *Eurohaptics 2001*, 2001
- [EV04] ERP, Jan B.F. V. ; VEEN, Hendrik A.H.C. V.: Vibrotactile in-vehicle navigation system. In: *Transportation Research Part F: Traffic Psychology and Behaviour* 7(4-5) (2004), S. 247–256
- [EVJD05] ERP, J. B. F. ; VEEN, H. A. H. C. ; JANSEN, Chris ; DOBBINS, Trevor: Waypoint navigation with a vibrotactile waist belt. In: *ACM Transactions on Applied Perception* 2 (2005), S. 106–117. – ISSN 1544–3558

- [FE97] FREUNDSCHUH, Scott M. ; EGENHOFER, Max J.: human conception of spaces: implications for Geographic Information System. In: *Transactions in GIS* 2 (4) (1997), S. 361–375
- [FH03] FIELD, Andy ; HOLE, Graham ; FIELD, Andy (Hrsg.) ; HOLE, Graham (Hrsg.): *How to design and report experiments*. SAGE Publications, 2003
- [Fie66] FIEANDT, Kai von (Hrsg.): *The world of perception*. The Dorsey Press . Homewood, Illinois, 1966
- [FISH99] FUKUDA, Hisaji ; INOUE, Takafumi ; SATO, Yukimasa ; HAYASHI, Yumeko: Study on Level Crossing Design and Evaluation Method based on Cognitive Model. In: *Quarterly Report of RTRI* 40 (1999), S. 26–31
- [FK03] FOLLMER, Robert ; KUNERT, Uwe: Methodological Advances in National Travel Surveys: Mobility in Germany 2002. In: *10th International Conference on Travel Behaviour Research Lucerne*, 2003
- [Fre07] FREY, Martin: CabBoots: shoes with integrated guidance system. In: *Proceedings of the 1st international conference on Tangible and embedded interaction, TEI '07*, 2007
- [Gav87] GAVER, William W.: Auditory Icons: Using Sound in Computer Interfaces. In: *SIGCHI Bulletin* 19 (4) (1987), S. 74
- [GDM02] GUNTHER, Eric ; DAVENPORT, Glorianna ; MODHRAN, Sile O.: Cutaneous Grooves: Composing for the Sense of Touch. In: *NIME '02 Proceedings of the 2002 conference on New interfaces for musical expression*, 2002
- [GGF94] GEORGE, Kellie ; GREEN, Paul ; FLEMING, Jill: Timing of auditory route-guidance instructions / Transportation Research Institute (UMTRI), The University of Michigan. 1994. – Forschungsbericht
- [GH93] GOBLE, Alan K. ; HOLLINS, Mark: Vibrotactile adaptation enhances amplitude discrimination. In: *Journal of the Acoustical Society of America* 93(1) (1993), S. 418–424

- [GHK08] GRECH, Michelle R. ; HORBERRY, Tim ; KOESTER, Thomas: *Human Factors in the Maritime Domain*. CRC Press Inc, 2008
- [Gol80] GOLDSTEIN, E. B. (Hrsg.): *Sensation and perception*. Books/Cole publishing Company, 1980
- [Gol10] GOLDSTEIN, E. B.: *Sensation and Perception*. Cengage Learning, 2010, 2010
- [Gre96] GREEN, Paul: In-Vehicle Information: Design of Driver Interfaces for Route Guidance. In: *Hot Topics in Freeway Operations: Compatibility of Information to Motorists (Transportation Research Board Meeting Washington, D.C.)*, 1996
- [Gro03] GROSS, Tom: Ambient Interfaces: Design Challenges and Recommendations. In: *In Proceedings of the 10th International Conference on Human-Computer Interaction*, 2003
- [Gui08] GUICHET, Bernard: Lessons Resulting from 18,000 Personal Injuries at French Roundabouts. In: *National Roundabout Conference*, 2008
- [Gun01] GUNTHER, Eric: *Skinscape: A Tool for Composition in the Tactile Modality*, Department of Electrical Engineering and Computer Science, Masters of Engineering, Massachusetts Institute of Technology, Diss., 2001
- [HB07] HOGGAN, Eve E. ; BREWSTER, Stephen A.: New parameters for tacton design. In: *Extended Abstracts Proceedings of the 2007 Conference on Human Factors in Computing Systems, CHI 2007*, 2007
- [HBJ08] HOGGAN, Eve E. ; BREWSTER, Stephen A. ; JOHNSTON, Jody: Investigating the effectiveness of tactile feedback for mobile touchscreens. In: *Proceedings of the 2008 Conference on Human Factors in Computing Systems*, 2008
- [HD01] HANCOCK, Von Peter A. ; DESMOND, Paula A. ; HANCOCK, Von Peter A. (Hrsg.) ; DESMOND, Paula A. (Hrsg.): *Stress, Workload, and Fatigue*. Lawrence Erlbaum Associates, Inc., 2001

- [Heu08] HEUTEN, Wilko: *Non-Visual Support for Navigation in Urban Environments*, Carl von Ossietzky Universität Oldenburg, Diss., 2008
- [HHPB08] HEUTEN, Wilko ; HENZE, Niels ; PIELOT, Martin ; BOLL, Susanne: Tactile Wayfinder: A non-visual support system for wayfinding. In: *NordiCHI 2008*, 2008
- [HHR06] HU, Pat ; HWANG, Ho-Ling ; REUSCHER, Tim: TRENDS IN NEW YORK STATE LONG-DISTANCE TRAVEL: Based on 2001 National Household Travel Survey / Office of Transportation Policy and Strategy New York State Department of Transportation Albany, New York 12232. 2006. – Forschungsbericht
- [HR71] HELD, Richard (Hrsg.) ; RICHARDS, Whitman (Hrsg.): *Perception: Mechanisms and Models: Readings from "Scientific American"*. Scientific American Inc., 1971
- [HR10] HWANG, Sungjae ; RYU, Jung hee: The Haptic steering Wheel: Vibro-tactile based navigation for the driving environment. In: *IEEE International Conference on Pervasive Computing and Communications Workshops (PERCOM Workshops) 8th*, 2010
- [HS88] HART, Sandra G. ; STAVELAND, Lowell E.: Development of a NASA-TLX (task load index): results of empirical and theoretical research. In: *Human Mental Workload*, 1988
- [HS05] HAIDER, Manfred ; SANDBERG, Ulf: Noise classification of urban road surfaces: / Silence. 2005. – Forschungsbericht
- [HT73] HOWARD, Ian P. ; TEMPLETON, William B.: *Human spatial orientation*. John Wiley & Sons, 1973
- [HTS05] HO, Cristy ; TAN, Hong Z. ; SPENCE, Charles: Using spatial vibrotactile cues to direct visual attention in driving scenes. In: *Transportation Research Part F: Traffic Psychology and Behaviour* 8 (6) (2005), S. 397–412
- [HVEK09] HOGEMA, Jeroen H. ; VRIES, Sjoerd C. D. ; ERP, Jan B. F. V. ; KIEFER, Raymond J.: A Tactile Seat for Direction Coding in Car

- Driving: Field Evaluation. In: *IEEE Transactions on Haptics* 2 (4) (2009), S. 181–188
- [HW03] HORREY, William J. ; WICKENS, Christopher D.: MULTIPLE RESOURCE MODELING OF TASK INTERFERENCE IN VEHICLE CONTROL, HAZARD AWARENESS AND IN-VEHICLE TASK PERFORMANCE. In: *PROCEEDINGS of the Second International Driving Symposium on Human Factors in Driver Assessment, Training and Vehicle Design*, 2003, S. 7–12
- [Inc08] *Incoming-Tourism Germany*. German National Tourist Board, 2008
- [JS08] JONES, L. A. ; SARTER, N. B.: Tactile Displays: Guidance for Their Design and Application. In: *Human Factors* 50 (2008), S. 90–111
- [JWV⁺08] JANSEN, Chris ; WENNEMERS, Antoon ; VOS, Wouter ; ; GROEN, Eric: FlyTact: A Tactile Display Improves a Helicopter Pilot's Landing Performance in Degraded Visual Environments. In: *EuroHaptics 2008*, 2008
- [KB02] KITCHIN, Rob ; BLADES, Mark ; KITCHIN, Rob (Hrsg.) ; BLADES, Mark (Hrsg.): *The Cognition Of Geographic Space*. I.B Tauris & Co Ltd, 2002
- [KMH⁺09] KERN, Dagmar ; MARSHALL, Paul ; HORNECKER, Eva ; ROGERS, Yvonne ; SCHMIDT, Albrecht: Enhancing Navigation Information with Tactile Output Embedded into the Steering Wheel. In: *Pervasive'09* 7 (2009), S. 42–58
- [Lan56] LANGFELD, Herbert S. (Hrsg.): *The Human senses*. John Wiley & Sons, 1956
- [LFH05] LEE, Joonhwan ; FORLIZZI, Jodi ; HUDSON, Scott: Studying the Effectiveness of MOVE: A Contextually Optimized In-Vehicle Navigation System. In: *CHI 2005*, 2005
- [Loo81] LOOMIS, J. M.: Tactile Pattern Perception. In: *Perception* 10 (1981), S. 5–27

- [LPS⁺07] LUNDGREN, Ulrika ; PETERS, Judith ; SMULDERS, Marc ; JOHNSTON, Scott ; LOETZER, Maarten: Independent research by Dutch research institute TNO shows that satellite navigation systems have positive influence on road safety / TNO. 2007. – Forschungsbericht
- [Mac03] MACKETT, Roger L.: Why do people use their cars for short trips? In: *Transportation* 30 (3) (2003), S. 329–349
- [Man05] MANSFIELD, Neil J.: *Human Response To Vibration*. CRC Press, 2005
- [Mas06] MASSDOT : MASSACHUSETTS DEPARTMENT OF TRANSPORTATION (Hrsg.): *Project Development & Design Guide : Intersection Design*. MassDot : Massachusetts Department of Transportation, 2006. – <http://www.massdot.state.ma.us/highway/DoingBusinessWithUs/ManualsPublicationsForms/ProjectDevelopmentDesignGuide.aspx> (Last accessed July2013)
- [Mat11] MATHER, George (Hrsg.): *Essentials of Sensation and Perception*. Routledge Taylor & Francis Group, 2011
- [MF90] MARK, David M. (Hrsg.) ; FRANK, Andrew U. (Hrsg.): *Cognitive and linguistic aspects of geographic space*. Kluwer Academic Publisher, 1990
- [MKC74] MCDANIEL, Troy ; KIRSHNA, Sreekar ; COLBRY, Dirk: Using Tactile Rhythm to Convey Interpersonal Distances to Individuals who are Blind. In: *CHI-2009*, 4669-4674
- [MO09] MOERE, Andrew V. ; OFFENHUBER, Dietmar: Beyond Ambient Display: A Contextual Taxonomy of Alternative Information Display. In: *International Journal of Ambient Computing and Intelligence* 1 (2) (2009), S. 39–46
- [MSH04] MATHIAS, Charles W. ; STANFORD, Matthew S. ; HOUSTON, Rebecca J.: The physiological experience of the Paced Auditory Serial Addition Task (PASAT): Does the PASAT induce autonomic arousal? In: *Archives of Clinical Neuropsychology* 19(4) (2004), S. 543–554

- [MSS03] McNAMARA, Timothy P. ; SHELTON, Amy L. ; SHELTON, Amy L.: Cognitive Maps and the Hippocampus. In: *Trends in cognitive sciences* 7(8) (2003), S. 333–335
- [MWCA⁺10] MEDEIROS-WARD, Nathan ; COOPER, Joel M. ; ANDREW, J. ; STRAYER, David L. ; PROVANCHER, William R.: Bypassing the Bottleneck: The Advantage of Fingertip Shear Feedback for Navigational Cues. In: *Proc. of the Annual Meeting of the Human Factors and Ergonomics Society*, 2010
- [NCK⁺05] NAGEL, Saskia K. ; CARL, Christine ; KRINGE, Tobias ; MAERTIN, Robert ; KOENIG, Peter: Beyond sensory substitution-learning the sixth sense. In: *Journal of Neural Engineering* 2(4) (2005), December, Nr. 4, S. 13–26. – ISSN 1741–2552
- [Pai05] PAIN, Herbert J. ; PAIN, Herbert J. (Hrsg.): *The Physics of Vibrations and Waves*. John Willey & Sons, 2005
- [PHHB08] PIELOT, Martin ; HENZE, Niels ; HEUTEN, Wilko ; BOLL, Susanne: Evaluation of Continuous Direction Encoding with Tactile Belts. In: *Proceedings of the 3rd international workshop on Haptic and Audio Interaction Design*, Springer-Verlag Berlin, Heidelberg ©2008, 2008, S. 1 – 10
- [PKB10] BELOT, Martin ; KRULL, Oliver ; BOLL, Susanne: Where is my team? Supporting collaboration and situation awareness with tactile displays. In: *CHI '10*, 2010
- [Pla05] PLATZER, Edna: *Spatial Cognition research: The human navigation process and its comparability in complex real and virtual environments*, Universität der Bundeswehr München Fakultät für Pädagogik, Diss., 2005
- [PML91] PAUZIE, A. ; MARIN-LAMELLET, C.: Analysis of Aging Drivers Behaviors Navigating with In-Vehicle Visual Display Systems. In: *In-vehicle Navigation and Information Systems*, 1991
- [PPB09a] BELOT, Martin ; POPPINGA, Benjamin ; BOLL, Susanne: Understanding Tourists on a Bicycle Trip "In The Wild". In: *Mobile Living Lab '09 Workshop in conjunction with MobileHCI '09*:

The 11th international conference on Human computer interaction with mobile devices and services, 2009

- [PPB09b] POPPINGA, Benjamin ; PIELOT, Martin ; BOLL, Susanne: Tac-ticycle - A Tactile Display for Supporting Tourists on a Bicycle Trip. In: *MobileHCI '09: Proceedings of the 11th international conference on Human computer interaction with mobile devices and services, 2009*
- [RB00] ROSS, David A. ; BLASCH, Bruce B.: Wearable interfaces for orientation and wayfinding. In: *Assets '00: Proceedings of the fourth international ACM conference on Assistive technologies*. New York, NY, USA : ACM, 2000. – ISBN 1–58113–314–8, S. 193–200
- [RF09] RIENER, Andreas ; FERSCHA, Alois: Reconfiguration of Vibro-tactile Feedback Based on Drivers' Sitting Attitude. In: *International Conferences on Advances in Computer-Human Interactions, 2009*
- [RLY09] REGAN, Michael A. ; LEE, John D. ; YOUNG, Kristie L.: *Driver Distraction: Theory, Effects, and Mitigation*. CRC Press Taylor & Francis Group, 2009
- [RMF⁺96] ROSS, Tracy ; MIDTLAND, Kari ; FUCHS, Mick ; PAUZIÉ, Annie ; ENGERT, Andrea ; DUNCAN, Bruce ; VAUGHAN, Gill ; VERNET, Monique ; PETERS, Helmut ; BURNETT, Gary ; MAY, Andrew: HARDIE Design Guidelines Handbook: Human Factors Guide-lines for Information Presentation by ATT Systems / HARDIE Harmonisation of ATT Roadside and Driver Information in Europe DRIVE II Project V2008 Commission of the European Communi-ties R&D Programme: Telematics Systems in the Area of Trans- port (DRIVE II). 1996. – Forschungsbericht
- [Rob00] ROBINSON, Bruce W.: ROUNDABOUTS: An Informational Guide / US Dept. of Transportation. 2000. – Forschungsbericht
- [RRSK00] ROBINSON, Bruce W. ; RODEGERDTS, Lee ; SCARBOROUGH, Wade ; KITTELSON, Wayne: Roundabouts: An Informational

Guide / Kittelson & Associates, Inc. Portland. 2000. – Forschungsbericht

- [Rup00] RUPERT, A. H.: An instrumentation solution for reducing spatial disorientation mishaps. In: *Journal: IEEE Engineering in Medicine and Biology Magazine - IEEE ENG MED BIOL MAG* 19 (2) (2000), S. 71–80
- [RZF09] REN, Dongning ; ZHOU, Haotian ; FU, Xiaolan: A Deeper Look at Gender Difference in Multitasking: Gender-Specific Mechanism of Cognitive Control. In: *Natural Computation* 5 (2009), S. 13–17
- [SBLN08] SMETS, Nanja J. ; BRAKE, Guido M. ; LINDENBERG, Jasper ; NEERINCX, Mark A.: Effects of Mobile Map Orientation and Tactile Feedback on Navigation Speed and Situation Awareness. In: *Mobile Human Computer Interaction*, 2008
- [Set64] SETO, William W. ; SETO, William W. (Hrsg.): *Theory and problems of mechanical vibrations*. New York, Schaum Pub. Co., 1964
- [SG08] SCOTT, J.J ; GRAY, Robert: A Comparison of Tactile, Visual, and Auditory Warnings for Rear-End Collision Prevention in Simulated Driving. In: *Human Factors: The Journal of the Human Factors and Ergonomics Society* 50 (2) (2008), S. 264–275
- [SRF09] STRAUB, Markus ; RIENER, Andreas ; FERSCHA, Alois: Distance Encoding in Vibro-tactile Guidance Cues. In: *MobiQuitous 2009*, 2009
- [Sur09] SURVEY, National T.: General Household Survey (Longitudinal),. In: *National Travel Survey, Department for Transport; Family Expenditure Survey, Office for National Statistics;*. Office for National Statistics, 2009
- [Sva04] SVAHN, Fredrik: In-car navigation usage: An end-user survey on existing systems. In: *IRIS27*, 2004
- [TBK06] TONNIS, Marcus ; BROY, Verena ; KLINKER, Gudrun: A Survey of Challenges Related to the Design of 3D User Interfaces for Car Drivers. In: *3DUI '06 Proceedings of the 3D User Interfaces*, 2006

- [TKTN09] TANAKA, Kohei ; KISHINO, Yasue ; TERADA, Tsutomu ; NISHIO, Shojiro: A Destination Prediction Method Using Driving Contexts and Trajectory for Car Navigation Systems. In: *SAC09*, 2009
- [TNO07] TNO: Independent research by Dutch research institute TNO shows that satellite navigation systems have a positive influence on road safety. 2007. – Forschungsbericht
- [TP97] TAN, Hong Z. ; PENTLAND, Alex: Tactual Displays for Wearable Computing. In: *ISWC '97: Proceedings of the 1st IEEE International Symposium on Wearable Computers*, 1997. – ISBN 0-8186-8192-6
- [TY04] TSUKADA, Koji ; YASUMURA, Michiaki: ActiveBelt: Belt-type wearable tactile display for directional navigation. In: *Ubiquitous Computing*, 2004
- [VE01] VEEN, Henricus A. H. C. ; ERP, Jan B. F.: Tactile Information Presentation in the Cockpit. In: *Lecture Notes in Computer Science* 2058 (2001), 174–??
citeseer.ist.psu.edu/vanveen01tactile.html
- [VEK09] VRIES, Sjoerd C. ; ERP, Jan B. ; KIEFER, Raymond J.: Direction coding using a tactile chair. In: *Applied Ergonomics* 40 (2009), S. 477–484
- [VFS69] VERRILLO, Ronald T. ; FRAIOLI, Anthony J. ; SMITH, Robert L.: Sensation magnitude of vibrotactile stimuli. In: *Attention, Perception, & Psychophysics* 6 (6) (1969), S. 366–372
- [VGCD83] VERRILLO, Ronald ; GESCHIEDER, George ; CALMAN, Bruce ; DOREN, Clayton V.: Vibrotactile masking: Effects of one and two-site stimulation. In: *Attention, Perception, and Psychophysics* 33 (4) (1983), S. 379–387
- [VSE04a] VEEN, Hendrik-Jan van ; SPAPÉ, Migh ; ERP, Jan van: Waypoint Navigation on Land: Different Ways of Coding Distance to the Next Waypoint. In: *Proceeding of EuroHaptics'04*, 2004

- [VSE04b] VEEN, Hendrik-Jan van ; SPAPE, Migh ; ERP, Jan V.: Waypoint navigation on land: Different ways of coding distance to next waypoint. In: *EuroHaptics 2004*, 2004
- [Waa96] WAARD, Dick de: *The measurement of drivers' mental workload*. The Netherlands: University of Groningen, Traffic Research Centre., Diss., 1996
- [WBMT01] WAARD, Dick de (Hrsg.) ; BROOKHUIS, Karel (Hrsg.) ; MORAAL, Jan (Hrsg.) ; TOFFETTI, Antonella (Hrsg.): *Human Factors in Transportation, Communication, Health, and the Workplace*. Shaker Publishing, 2001
- [WBY⁺09] WU, Wen ; BLAICHER, Fabian ; YANG, Jie ; SEDER, Thomas ; CUI, Dehua: A Prototype of Landmark-Based Car Navigation Using a Full Windshield Head-Up Display System. In: *Proceedings of the 2009 workshop on Ambient media computing, AMC'09*, 2009
- [Wic84] WICKENS, Christopher D.: Processing resources in attention. In: *Processing resources in attention*. London:Academic, 1984
- [Wic08] WICKENS, Christopher D.: Multiple Resources and Mental Workload. In: *The Journal of the Human Factors and Ergonomics Society* 50(3) (2008), S. 449–455
- [WMVO05] WEBSTER, Robert J. ; MURPHY, Todd E. ; VERNER, Lawton N. ; OKAMURA, Allison M.: A Novel Two-Dimensional Tactile Slip Display: Design, Kinematics and Perceptual Experiments. In: *ACM Transactions on Applied Perception* 2 (2) (2005), S. 150–65